

L88 Blue

Thank you for choosing a product from Standby.

Technical Data

Lens	Polycarbonate
Housing	ABS, plastic (black)
Color	Blue
Diodes	4 high power LED
Cable	Single: 0.84 m (160 mm + 680 mm) + 2 m driver cable Double: 2x 0.84 m (160 mm + 680 mm) + 2 m driver cable
Power	10-30 V DC
Ambient temperature	-40°C to +85°C
Size	Lamp: Ø29 x 24.1 mm Driver (single): 80 x 14.3 x 18.6 mm Driver (double): 80 x 14 x 27 mm
Approvals	Light: ECE R65 (E5) EMC: ECE R10 (E5)
Included	Single: 1 x L88 Lamp Blue 1 x driver D13s 1 x grommet 1 x E5 label Double: 2 x L88 Lamp Blue 1 x driver D13d 2 x grommets 2 x E5 labels
Synchronizing	Up to 10 lamps (lamps and driver)
Input	Active on low flank

Factory Settings

Flash pattern	Sync mode
Double	Simultaneous

To change the flash pattern setting, see [Flash Pattern](#). To change the sync mode setting, see [Sync Mode](#).

Flash Pattern

Introduction

The flash pattern setting controls the flash pattern. There are four versions of flash pattern: Double, Triple, Steady burn 1 and Steady burn 2.

- **Double** and **Triple** are built-in flash patterns and no control system is needed.
- With **Steady burn 1** and **Steady burn 2** an external flasher or control system is used to control the flash pattern.

The factory setting of flash pattern is Double.

When in configuration mode, the number of **blank** flashes (lamp off) in the flash sequence show the current flash pattern setting, see table.

Blank flashes per flash sequence	Flash pattern	Flash control
1	Double	Built-in
2	Triple	Built-in
3	Steady burn 1	External
4	Steady burn 2	External

Setting the Flash Pattern

! WARNING

Risk of eye damage. Do not look into the beam at close range.

! WARNING

Hot surfaces. Do not touch the cooling flanges when the lamp is on.

1. If already in configuration mode, go to step 6.
2. If the lamp is connected to the power supply, disconnect it.
3. Connect the red wire to 10-30 V DC via a 5 A fuse.

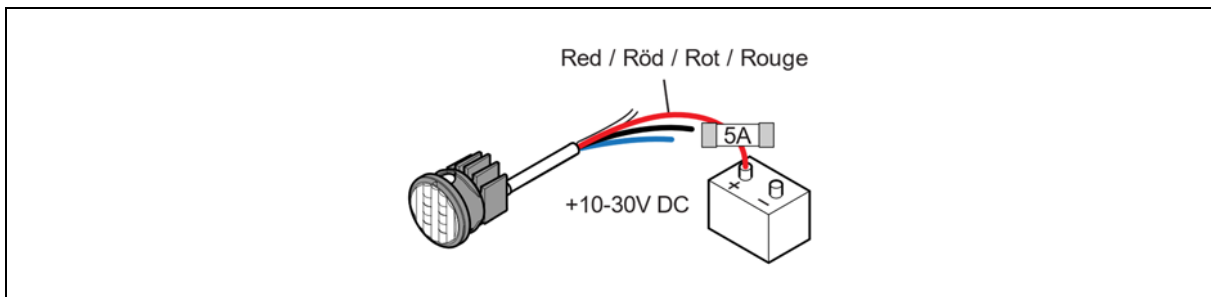

4. Connect the black wire to ground.

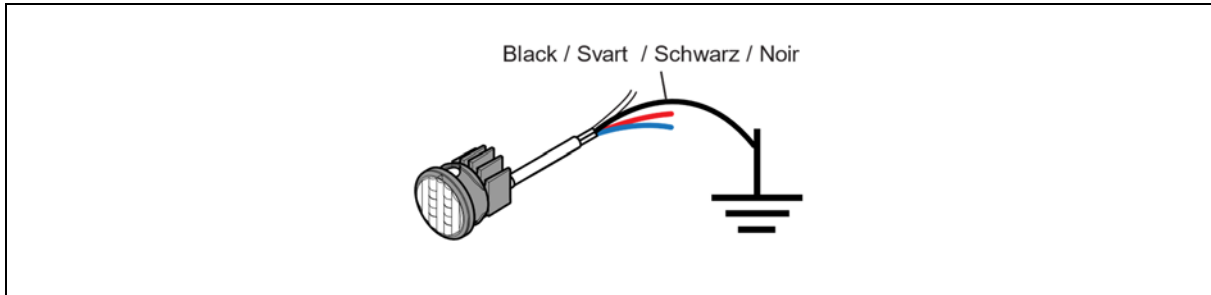

5. Within 1 to 6 sec: temporarily connect the white wire to ground and let it stay connected for at least 2 sec.

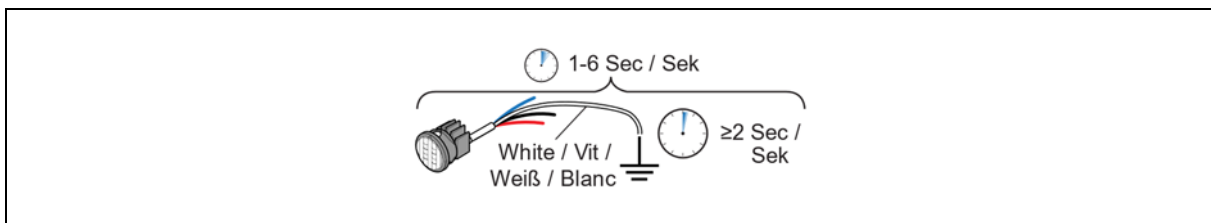

The lamp enters configuration mode and a flash sequence indicating the current settings starts.

! Note

If this step is performed incorrectly, you must restart from step 2.

6. Count the number of blank flashes (lamp off) per flash sequence to find out the current flash pattern setting.

7. Temporarily connect the white wire to ground to change to the next version of flash pattern. Each time the white wire is temporarily connected to ground the next version of flash pattern is selected.

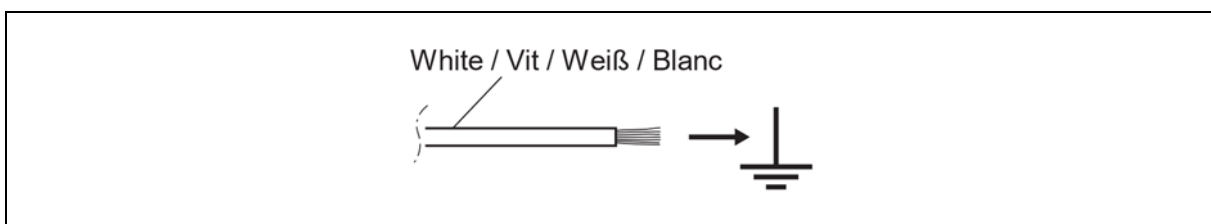

8. To change the sync mode setting, see [Sync Mode](#). To reset to factory settings, see [Factory Reset](#).

9. Disconnect the power supply to save the selected settings and exit configuration mode.

Sync Mode

Introduction

The sync mode setting controls how the flashing of two or more lamps is synchronized. There are two versions of sync mode: Simultaneous and Alternate.

- **Simultaneous** means that the lamps are in sync, that is they come on and go off at the same time.
- **Alternate** means that the lamps are out of sync.

The factory setting of sync mode is Simultaneous.

When in configuration mode, the number of **bright** flashes per flash sequence show the current sync mode setting, see table.

Bright flashes per flash sequence	Sync mode
1	Simultaneous
2	Alternate

Setting the Sync Mode

WARNING

Risk of eye damage. Do not look into the beam at close range.

WARNING

Hot surfaces. Do not touch the cooling flanges when the lamp is on.

1. If already in configuration mode, go to step 6.
2. If the lamp is connected to the power supply, disconnect it.
3. Connect the red wire to 10-30 V DC via a 5 A fuse.

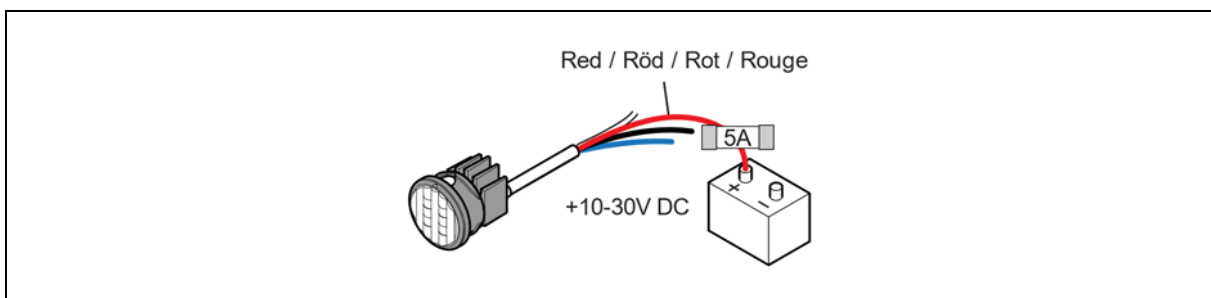

4. Connect the black wire to ground.

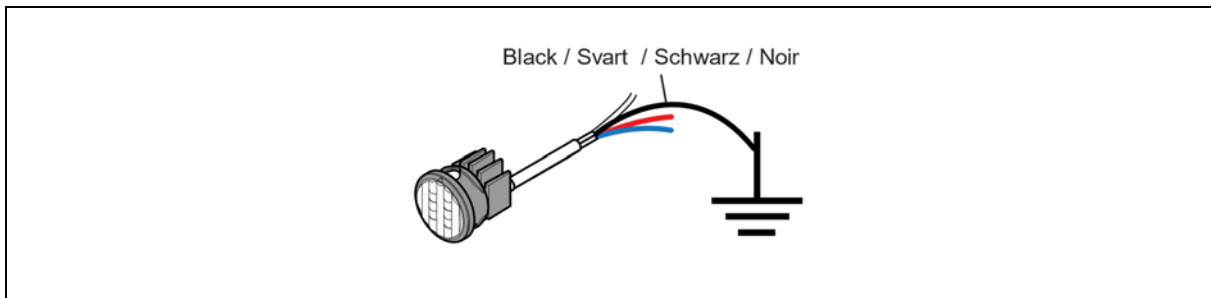

5. Within 1 to 6 sec: temporarily connect the white wire to ground and let it stay connected for at least 2 sec.

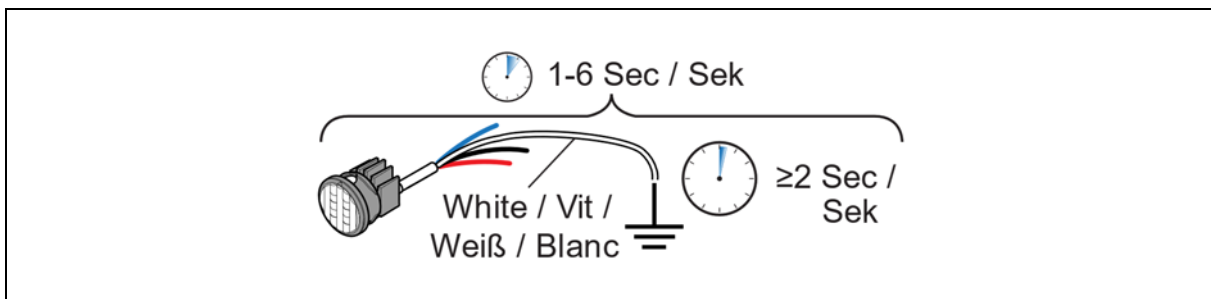

The lamp enters configuration mode and a flash sequence indicating the current settings starts.

! Note

If this step is performed incorrectly, you must restart from step 2.

6. Count the number of bright flashes per flash sequence to find out the current sync mode setting.

7. Temporarily connect the blue wire to ground to change to the next version of sync mode. Each time the blue wire is temporarily connected to ground the next version of sync mode is selected.

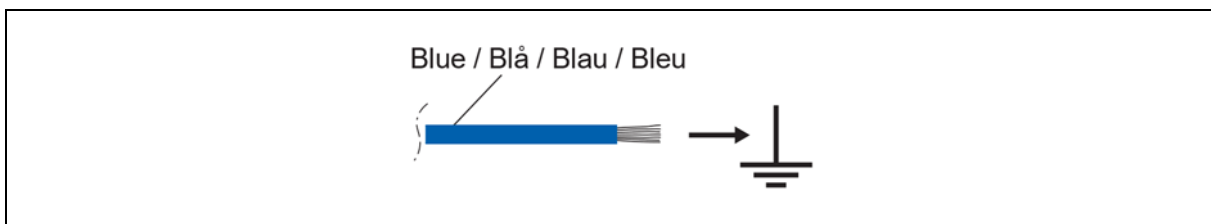

8. To change the flash pattern setting, see [Flash Pattern](#). To reset to factory settings, see [Factory Reset](#).

9. Disconnect the power supply to save the selected settings and exit configuration mode.

Factory Reset

Introduction

The settings can be changed back to the factory settings.

The factory settings are the following:

- Flash pattern – Double
- Sync mode - Simultaneous

Reset to Factory Settings

WARNING

Risk of eye damage. Do not look into the beam at close range.

WARNING

Hot surfaces. Do not touch the cooling flanges when the lamp is on.

Note

All current settings, that is both flash pattern setting and sync mode setting, are reset to the default settings.

1. If already in configuration mode, go to step 6.
2. If the lamp is connected to the power supply, disconnect it.
3. Connect the red wire to 10-30 V DC via a 5 A fuse.

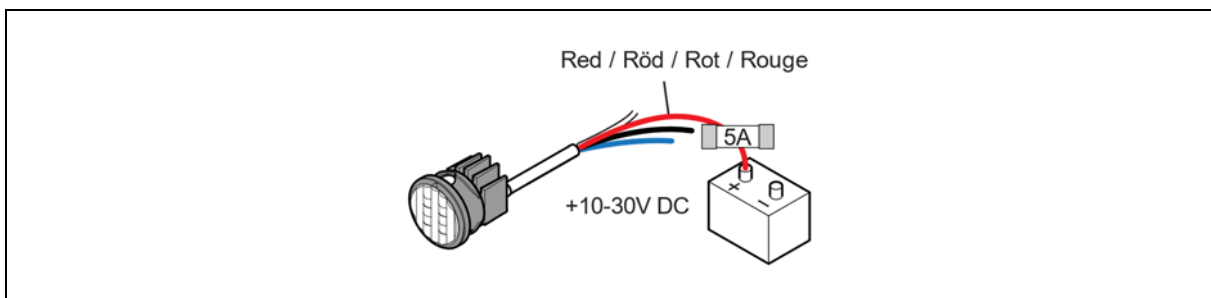

4. Connect the black wire to ground.

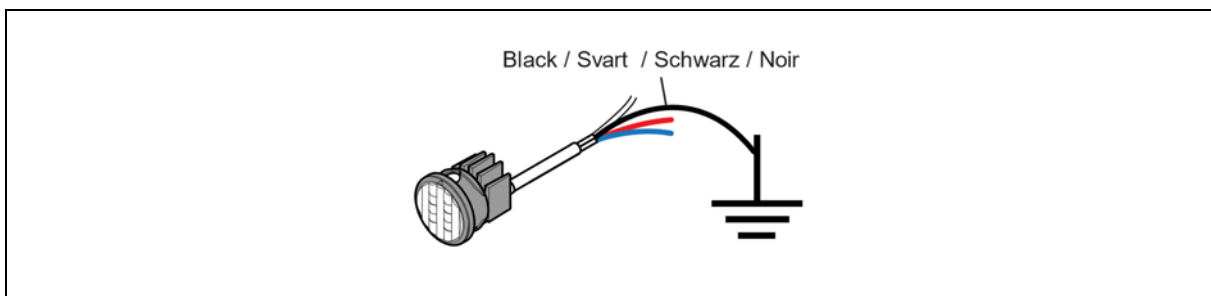

5. Within 1 to 6 sec: temporarily connect the white wire to ground and let it stay connected for at least 2 sec.

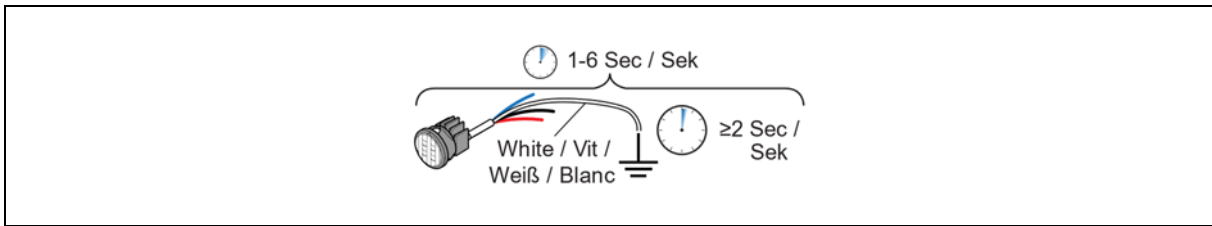

The lamp enters configuration mode and a flash sequence indicating the current settings starts.

! Note

If this step is performed incorrectly, you must restart from step 2.

6. Connect the **BLUE** and the **WHITE** wire to ground and let them stay connected for at least 2 seconds.

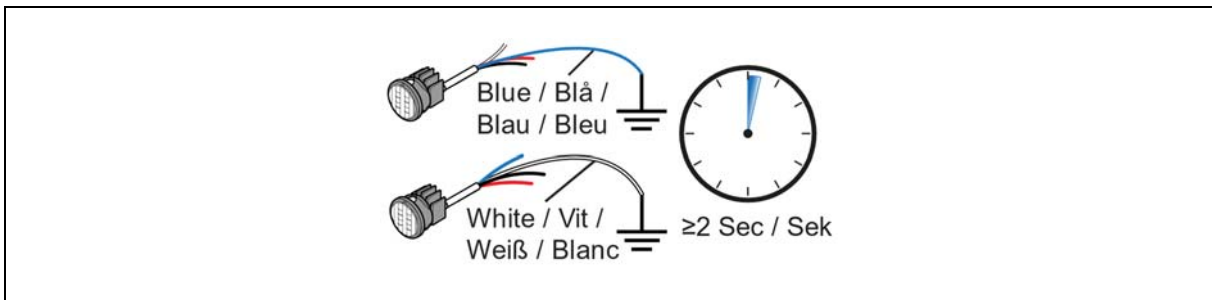

7. The reset is confirmed with a bright steady light for 2-3 seconds.

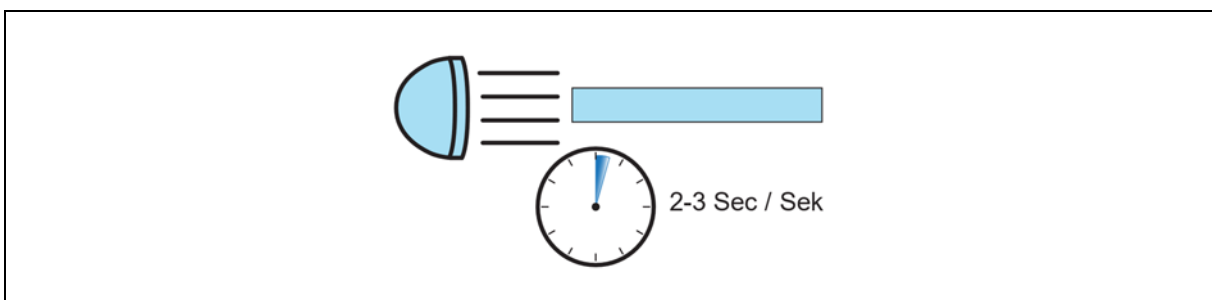

Connections

The function of each wire and how to connect the wires depend on the chosen flash pattern setting.

Table 1. Connections if flash pattern Double or Triple is selected.

Wire	Functions	Connect to	
Black	Power supply	Good and suitable ground	<p>Black / Svart / Schwarz / Noir</p> 
Red	Power supply Lamp on/off	10-30 V DC via a 5 A fuse Sourcing output (+) of an I/O unit or via a switch	<p>Red / Röd / Rot / Rouge</p> 
White	Synchronizing the flashing of two or more lamps	Sync cable of the other lamp	<p>White / Vit / Weiß / Blanc</p> 
Blue	Day-and-night function	Sinking output (-) of an I/O unit or via a switch to ground. When activated, the lamp dims down to night level	<p>Blue / Blå / Blau / Bleu</p> 

Table 2. Connections if flash pattern Steady burn 1 is selected.

Wire	Functions	Connect to	
Black	Power supply	Good and suitable ground	<p>Black / Svart / Schwarz / Noir</p> 
Red	Power supply	10-30 V DC via a 5 A fuse	<p>Red / Röd / Rot / Rouge</p> 
White	Lamp on/off	Sinking output (-) of an I/O unit or external flasher.	<p>White / Vit / Weiß / Blanc</p> 
Blue	Day-and-night function	Sinking output (-) of an I/O unit or via a switch to ground. When activated, the lamp dims down to night level	<p>Blue / Blå / Blau / Bleu</p> 

Table 3. Connections if flash pattern Steady burn 2 is selected.

Wire	Functions	Connect to	
Black	Power supply	Good and suitable ground	<p>Black / Svart / Schwarz / Noir</p> 
Red	Power supply Lamp on/off	10-30 V DC via a 5 A fuse Sourcing output (+) of an I/O unit or external flasher	<p>Red / Röd / Rot / Rouge</p> 
White	Synchronizing the flashing of two or more lamps	Sync cable of the other lamp	<p>White / Vit / Weiß / Blanc</p> 
Blue	Day-and-night function	Sinking output (-) of an I/O unit or via a switch to ground. When activated, the lamp dims down to night level	<p>Blue / Blå / Blau / Bleu</p> 

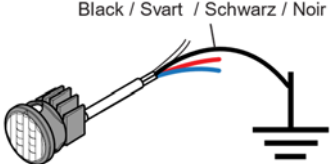
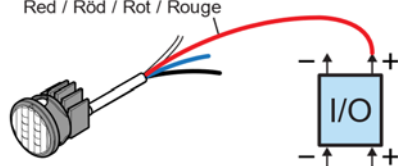
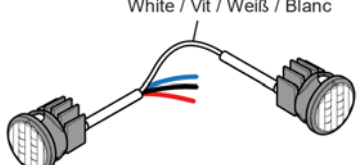
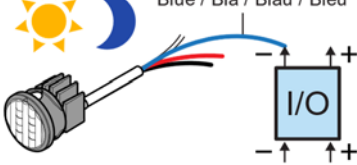
Installation

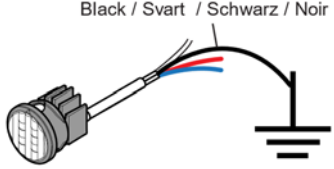
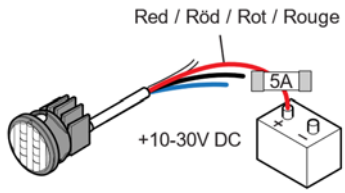
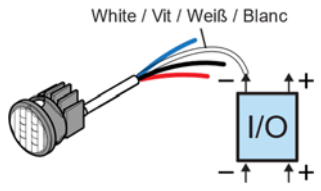
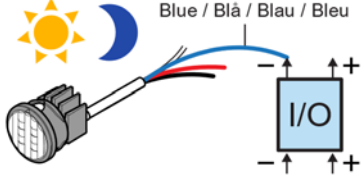
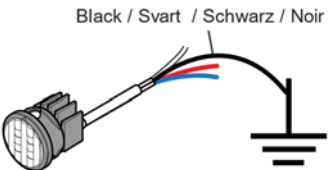
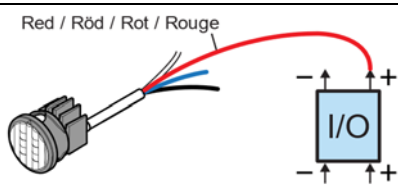
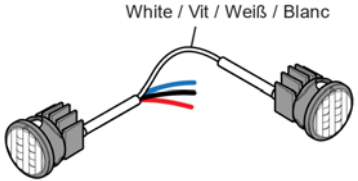
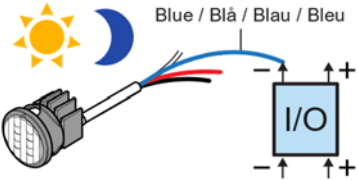
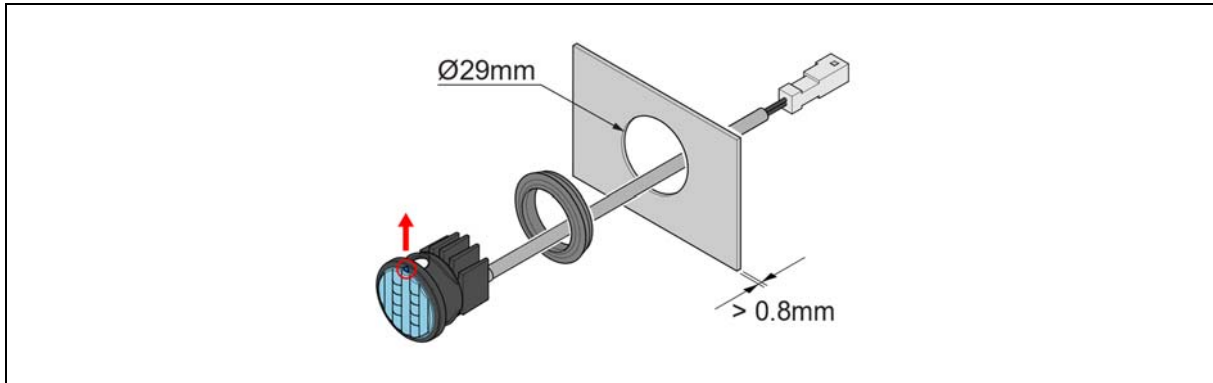

! CAUTION

To prevent moisture from entering the lamp through the cable end, make sure that the cable end is sealed or located in a dry part of the vehicle.

When using a pressure washer, keep a minimum distance of 40 cm.

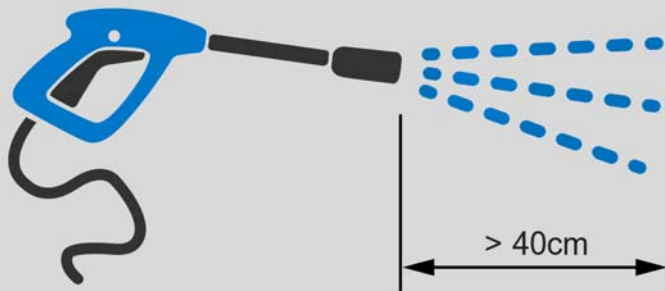

Do not let grease, oil or any foreign substances come in contact with the Gore-Tex™ membrane on the lamp.

Do not damage the Gore-Tex™ membrane on the lamp.

The driver must be located in a weather protected area.

