

# STANDBY®

 FRANCE

## UNISCREEN *ENSEMBLES CARÉNÉS*



# OBJECTIF



# PRINCIPE

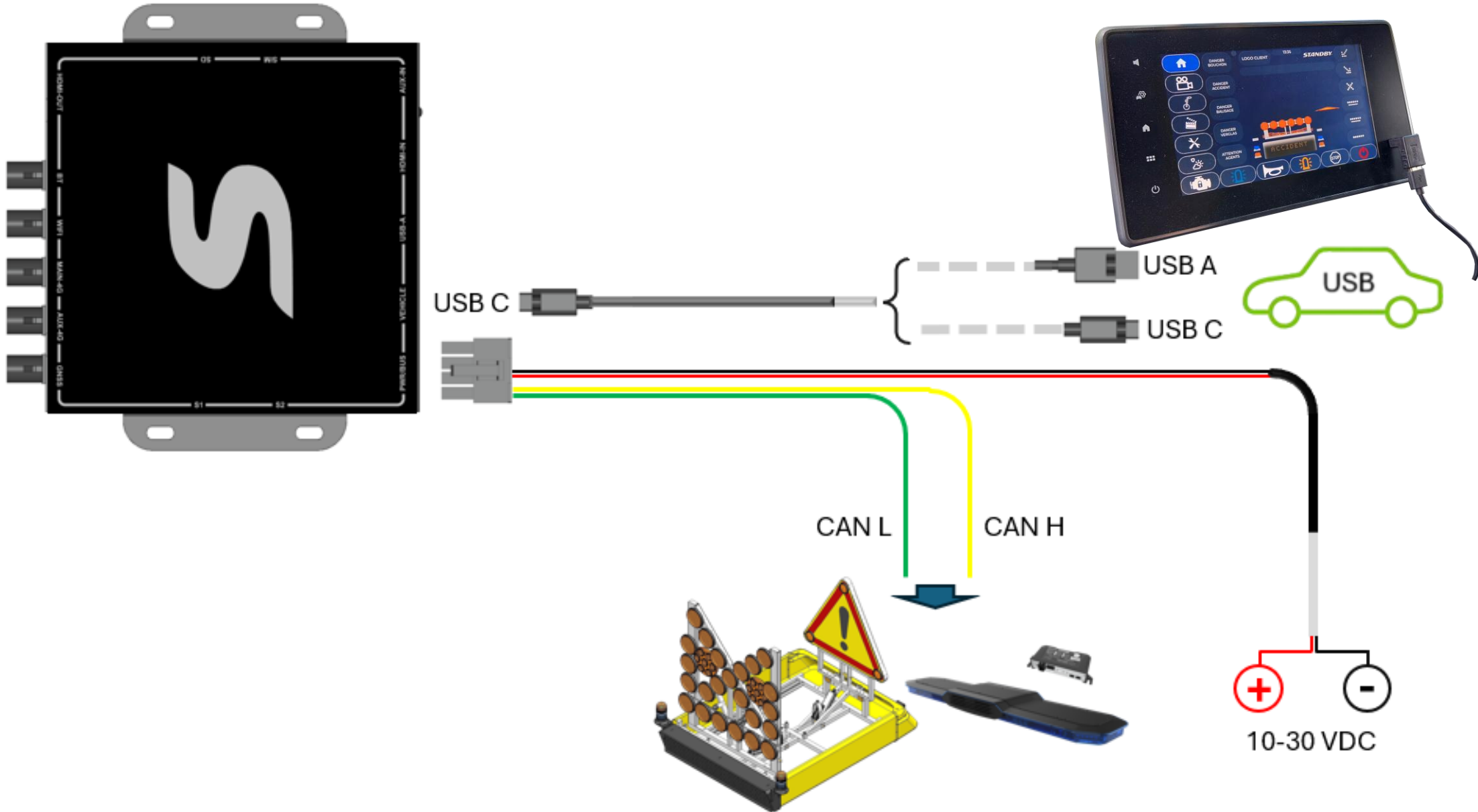

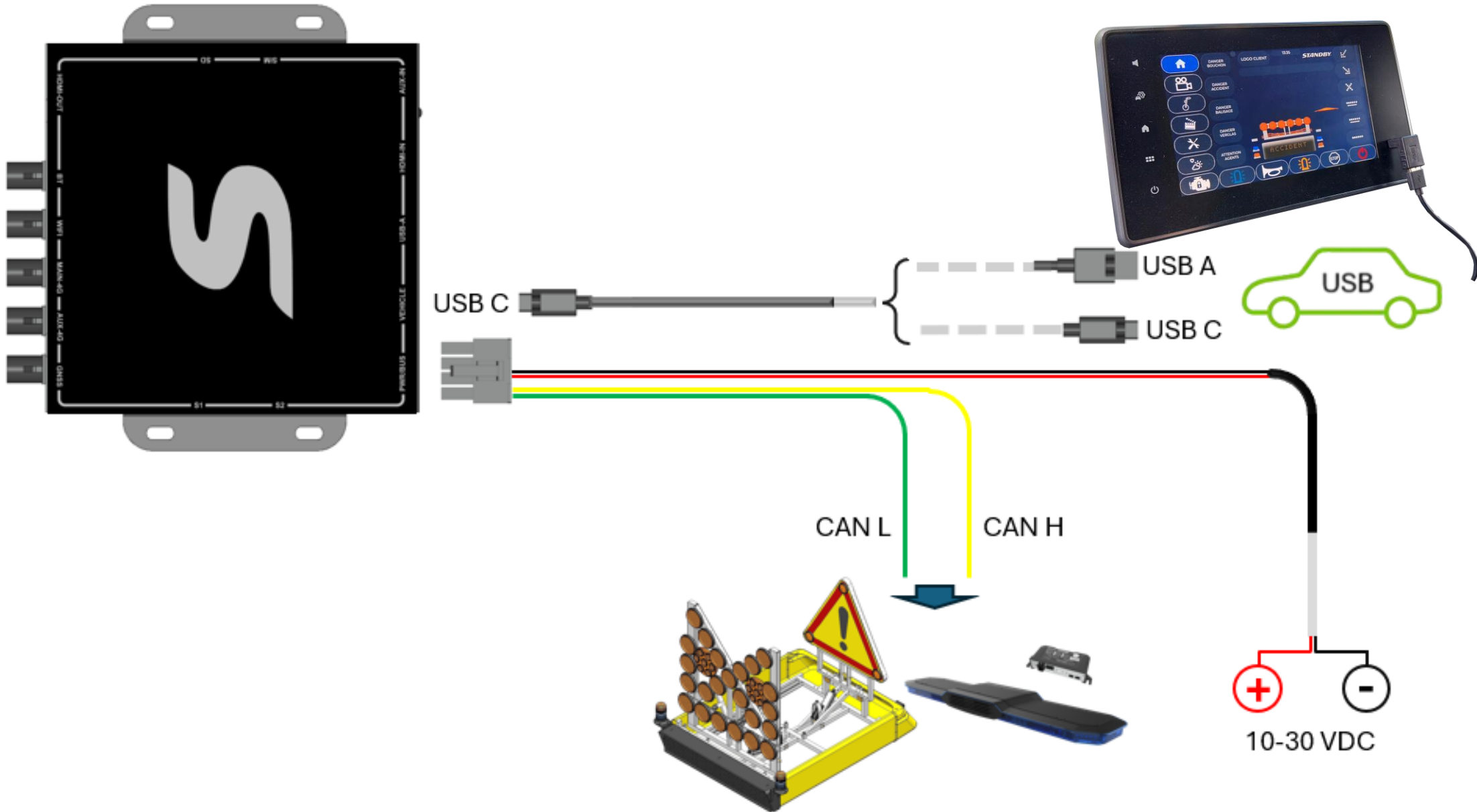

# COMPOSITION



USB-C



USB-A



FAISCEAU ALIMENTATION + CAN



S1: RESET, MISE A JOUR, CHANGEMENT PROTOCOLE

S2: ARRÊT WLAN ET BLUETOOTH

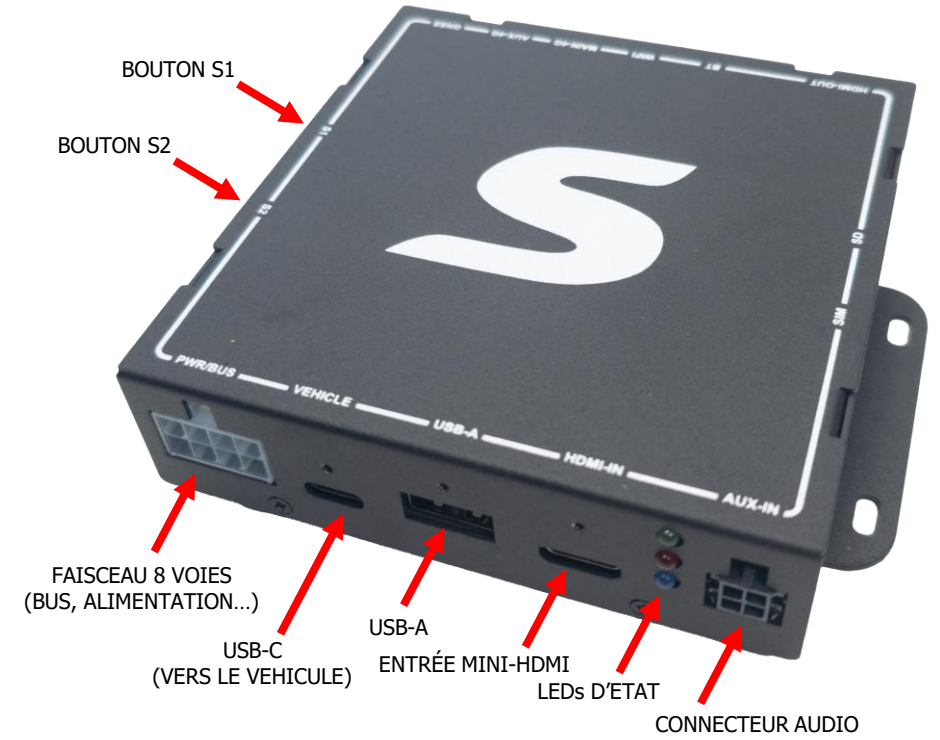
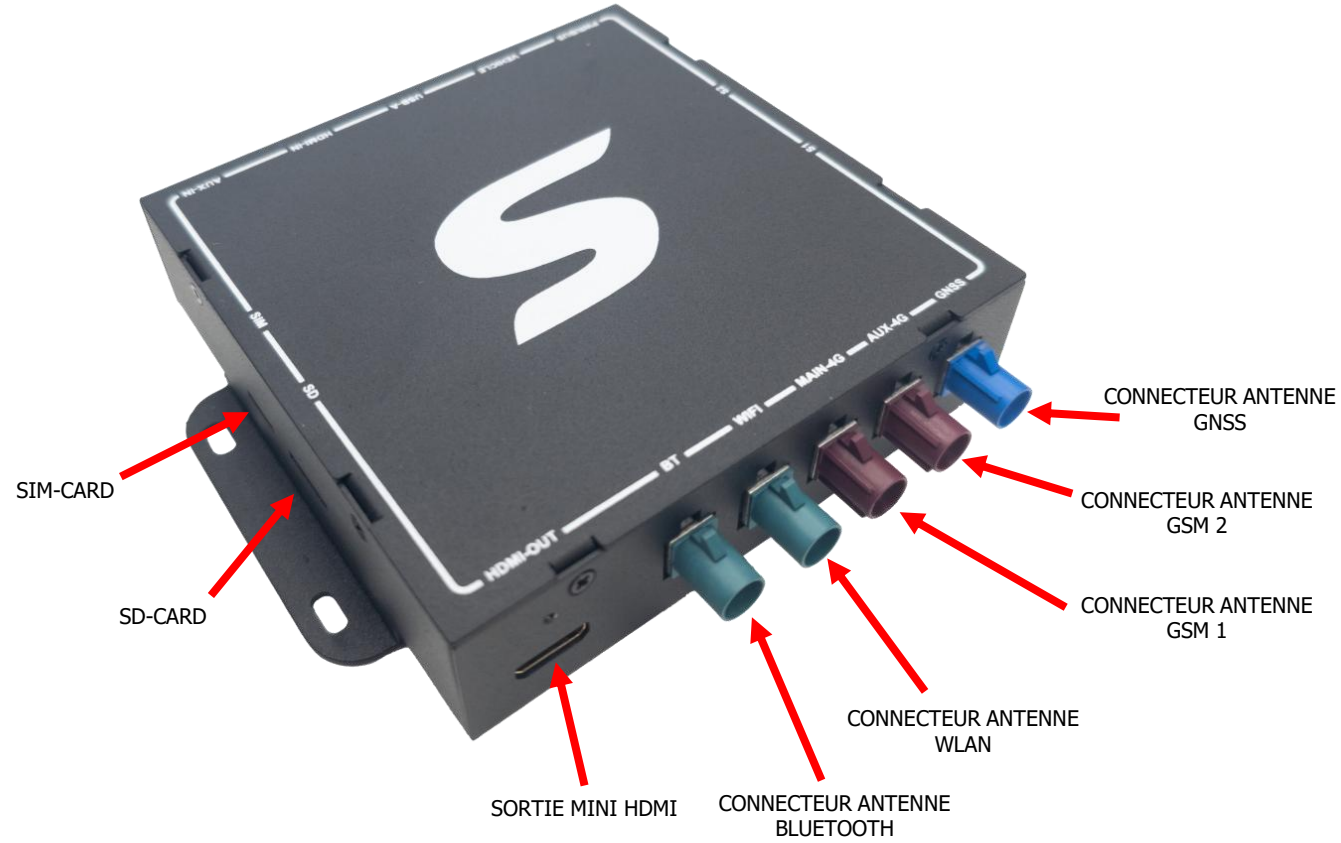

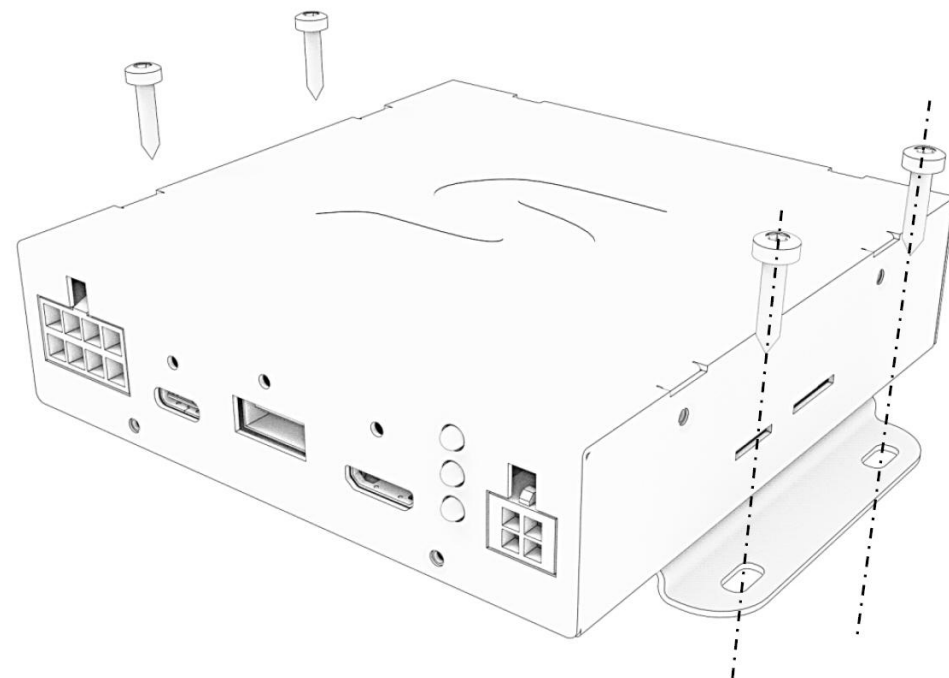
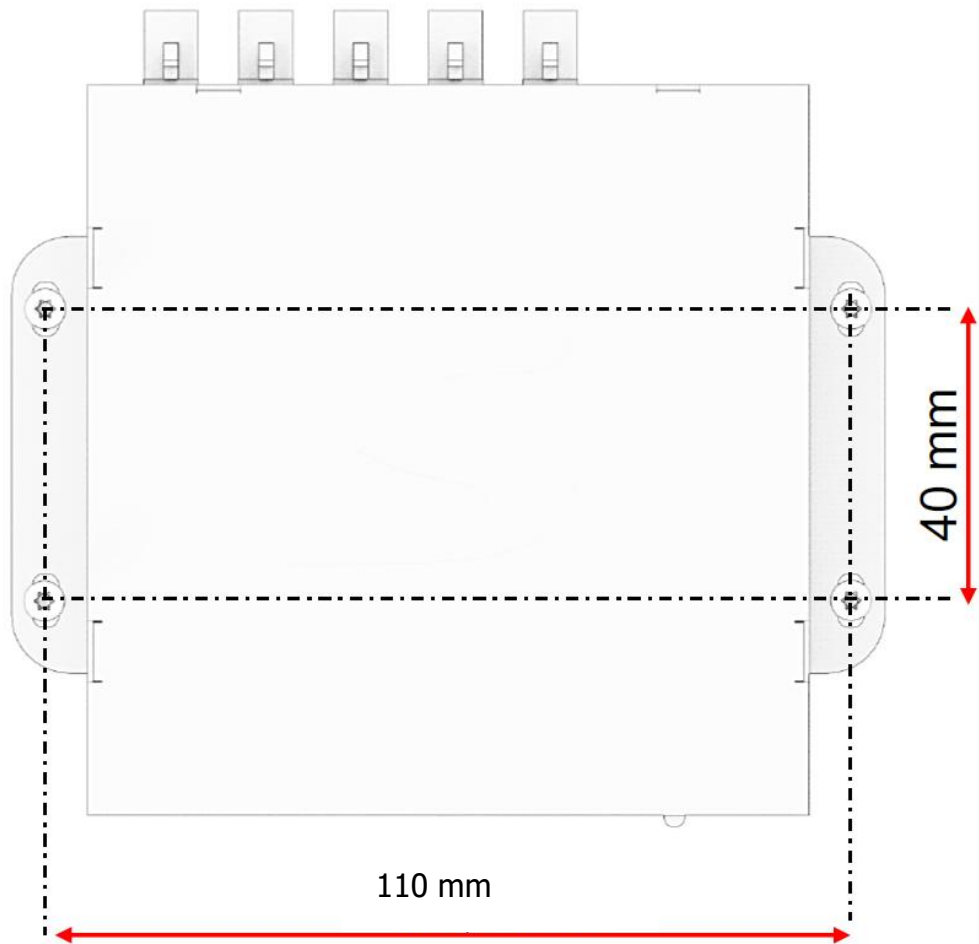

# UNISCREEN POUR ENSEMBLES CARÉNÉS



# RETROFIT

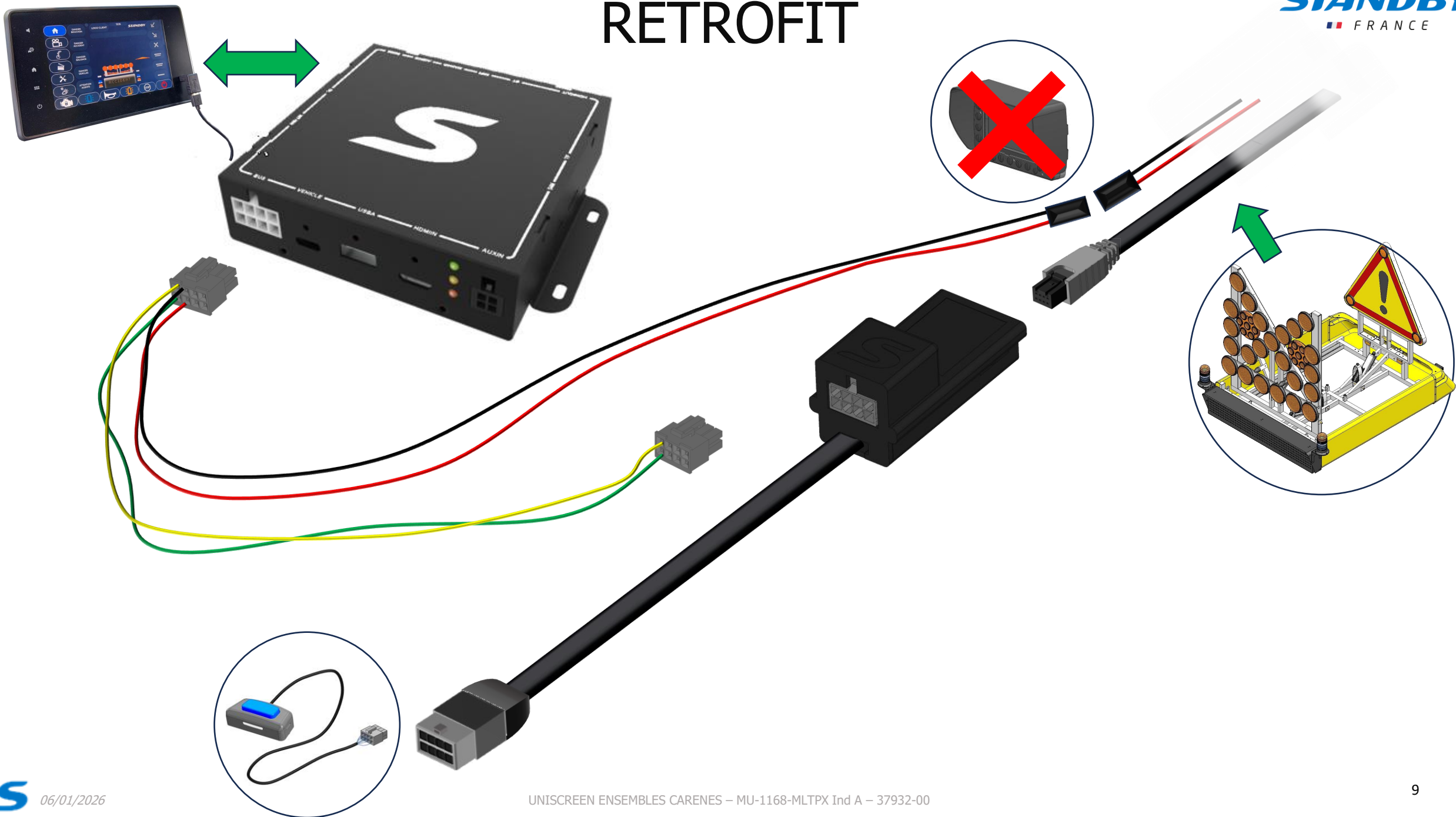

# INSTALLATION INITIALE

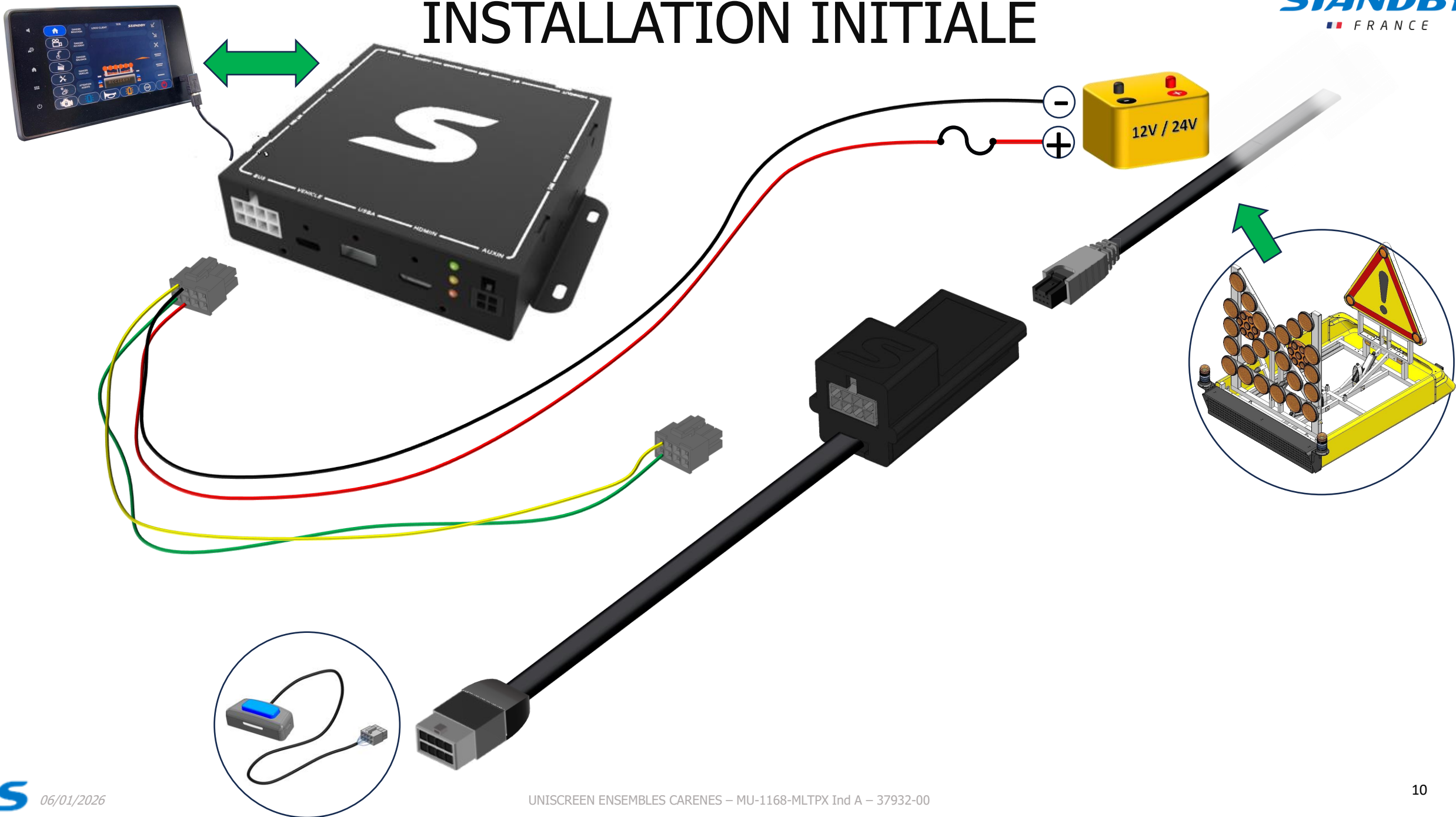

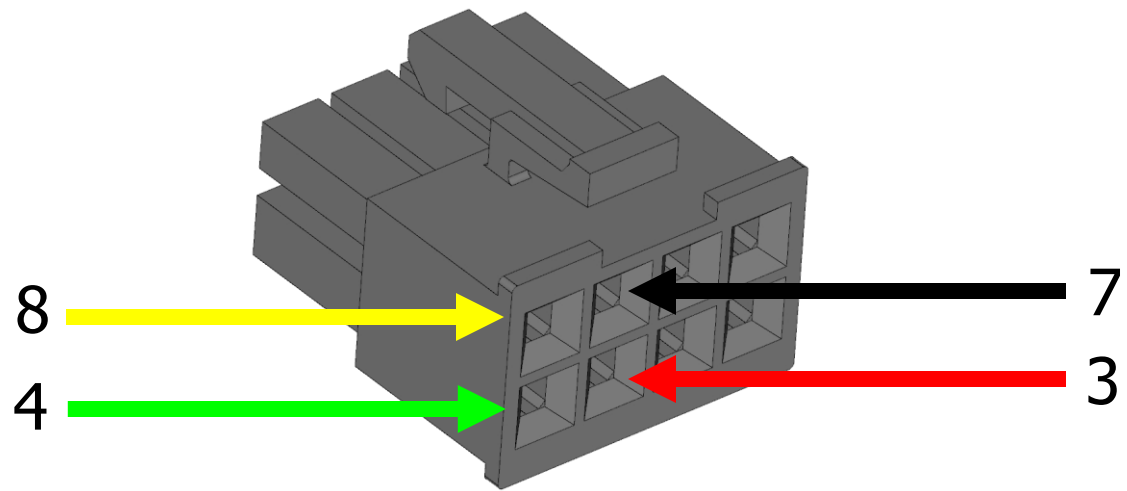

# OPTION VIDEO



vers mini-HDMI Unibox



Vers USB-A Unibox

MODULE CONVERTISSEUR  
VIDEO



Vers caméra

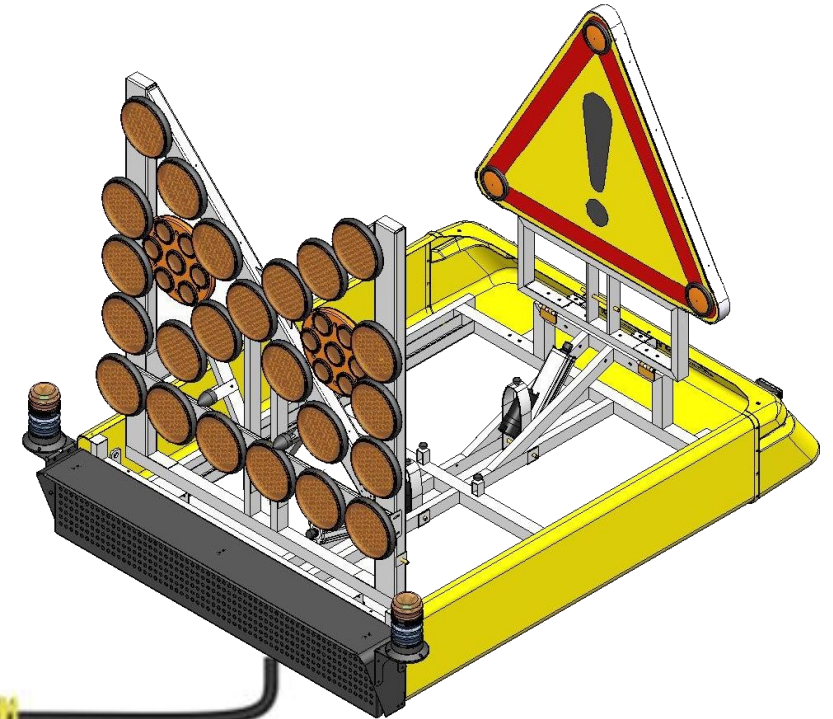

# PRESENTATION ECRAN



MENU SYSTEME

INTERFACE ENSEMBLE CARENE  
(PAGE D'ACCUEIL)

# LES ETATS DES COMMANDES

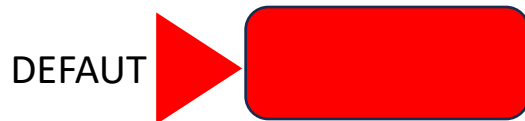

# MENU STANDARD

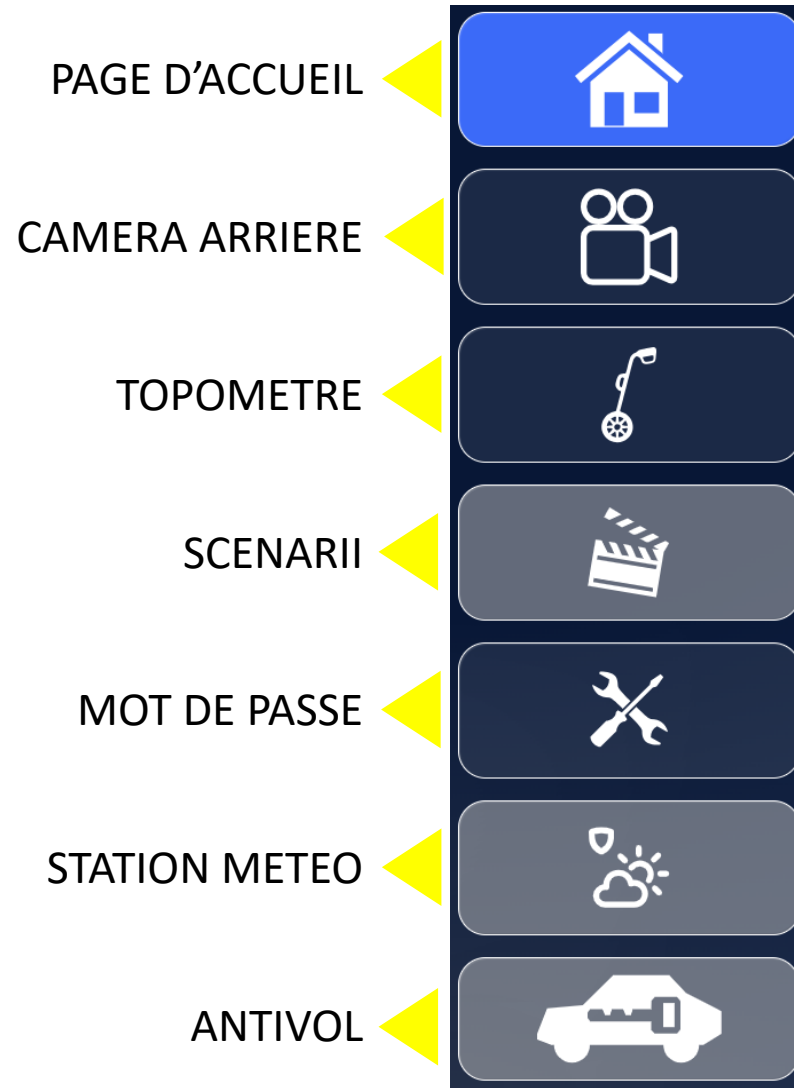

# INTERFACE ENSEMBLE CARENE



# MENU VIDEO



# MENU TOPOMETRE

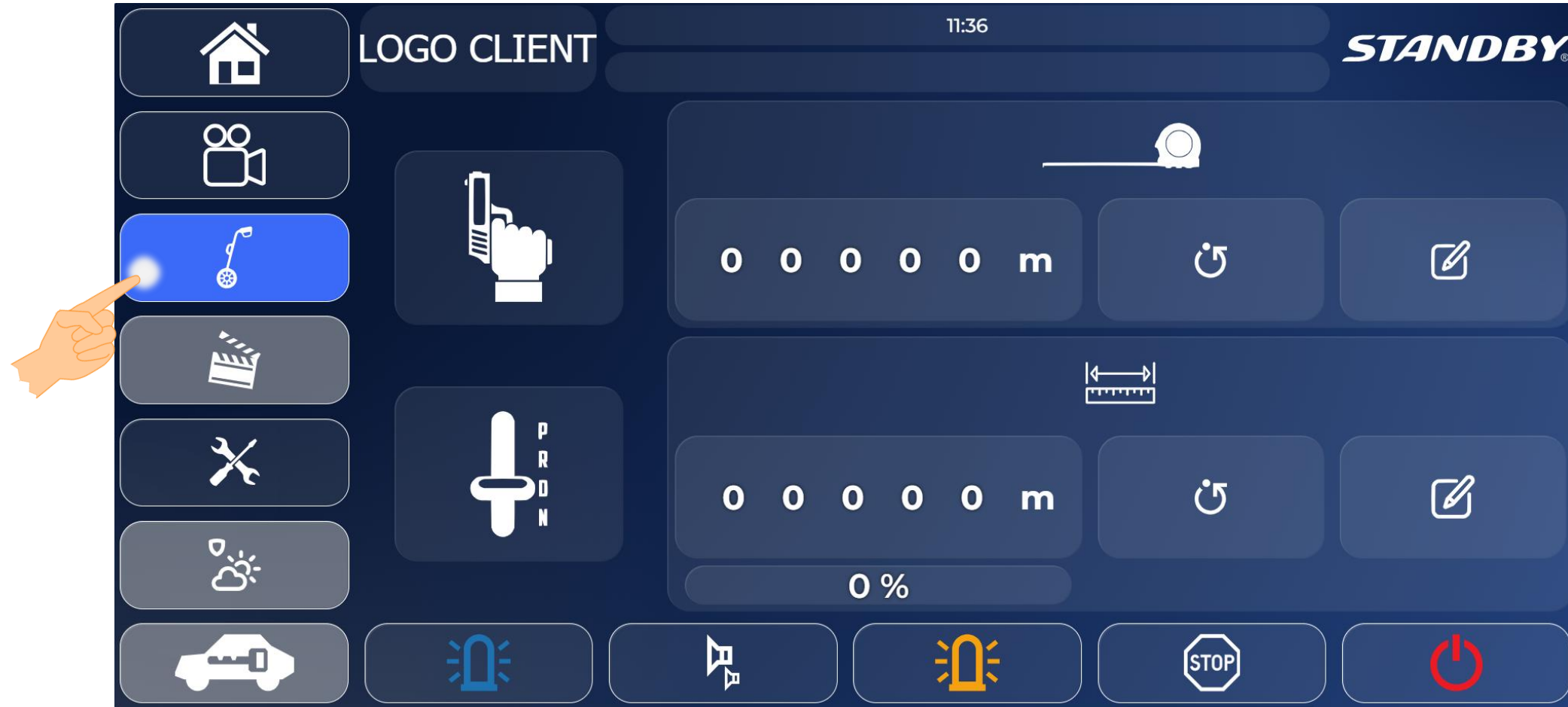

# TOPOMETRIE MARCHE AVANT



LOGO CLIENT 11:39 **STANDBY**

0 0 0 8 2 m

0 0 0 0 0 m

0 %

# TOPOMETRIE MARCHE ARRIERE



11:41

LOGO CLIENT

STANDBY®

0 0 1 5 0 m

0 0 0 0 0 m

0 %

P R O M

# TOPOMETRIE REGLAGE INTERDISTANCE



The screenshot shows the STANDBY control interface. At the top, it displays 'LOGO CLIENT', the time '12:00', and the 'STANDBY' logo. A vertical sidebar on the left contains icons for home, video, music, clapperboard, tools, weather, and a car. The main area features a hand icon, a distance display '0 0 0 0 0 m', a refresh button, and a save button. Below this, a yellow-bordered section contains a numeric keypad with arrows above and below the numbers, a distance display '0 0 2 0 0 m', a refresh button, and a save button. A hand icon is pointing at the first '0' in the second display. At the bottom, there are icons for a bell, a bell with 'PA', a red bell, a 'STOP' sign, and a power button.

# TOPOMETRIE MESURE INTERDISTANCE

LOGO CLIENT 12:03 **STANDBY**

0 0 1 1 3 m

0 0 2 0 0 m

56 % % PROGRESSION

# TOPOMETRIE ALARMES INTERDISTANCE

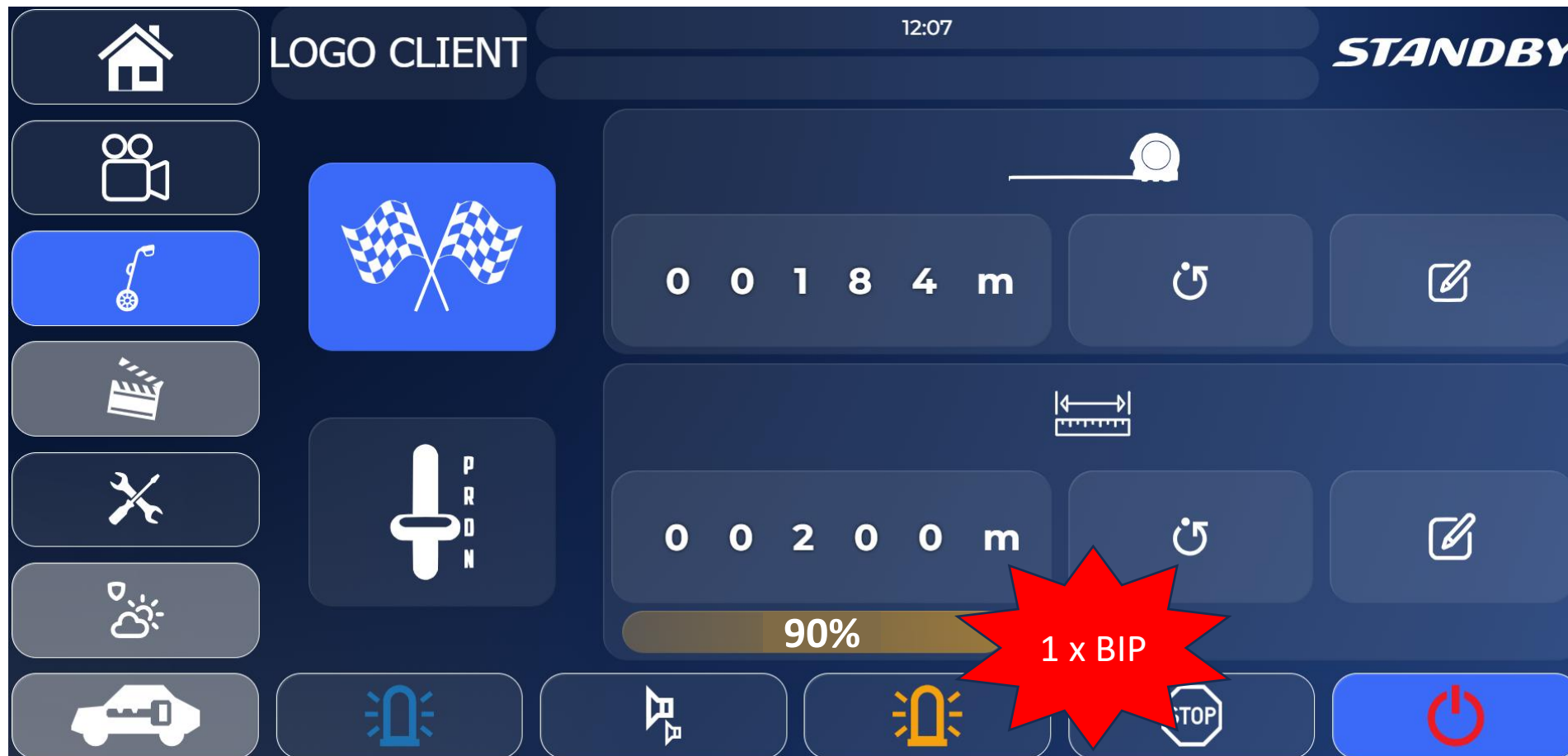

**1 x BIP** + 1 BIP au retour à 0 après 100%

# MENU SCENARII



# ENTREE MENU SYSTEME



# MOT DE PASSE AFFICHÉ

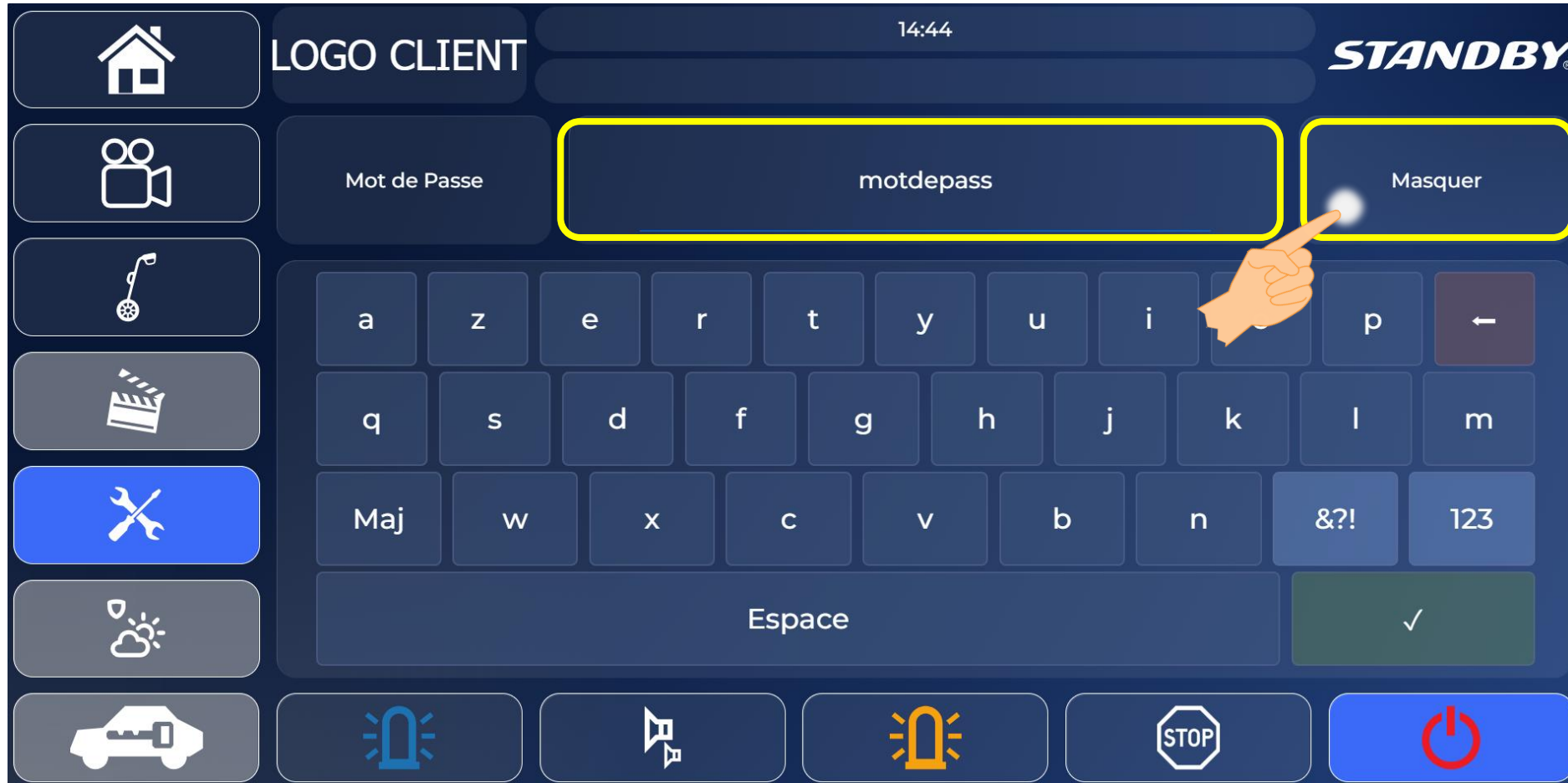

# MENU REGLAGES SYSTEME

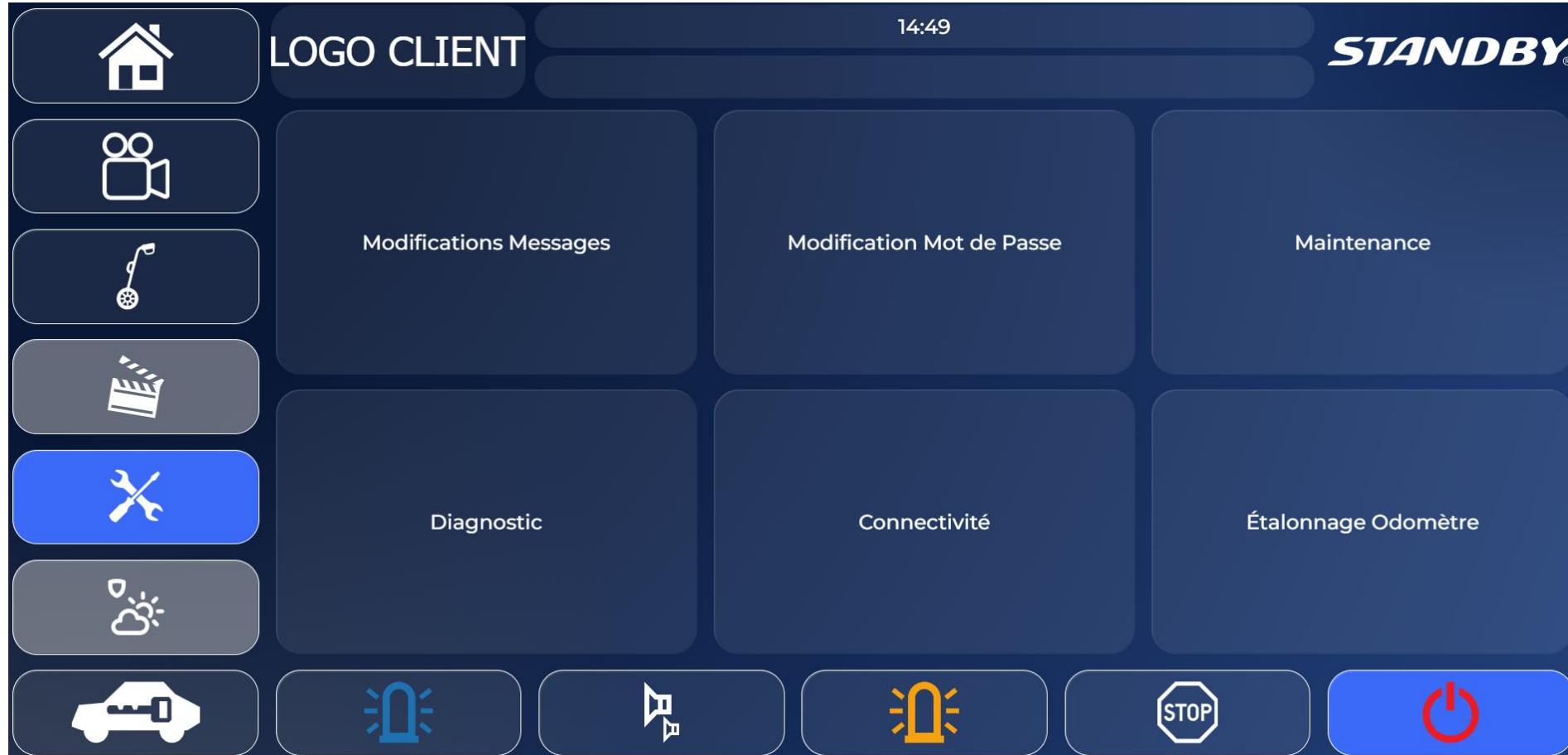

# MENU MODIFICATION MESSAGES

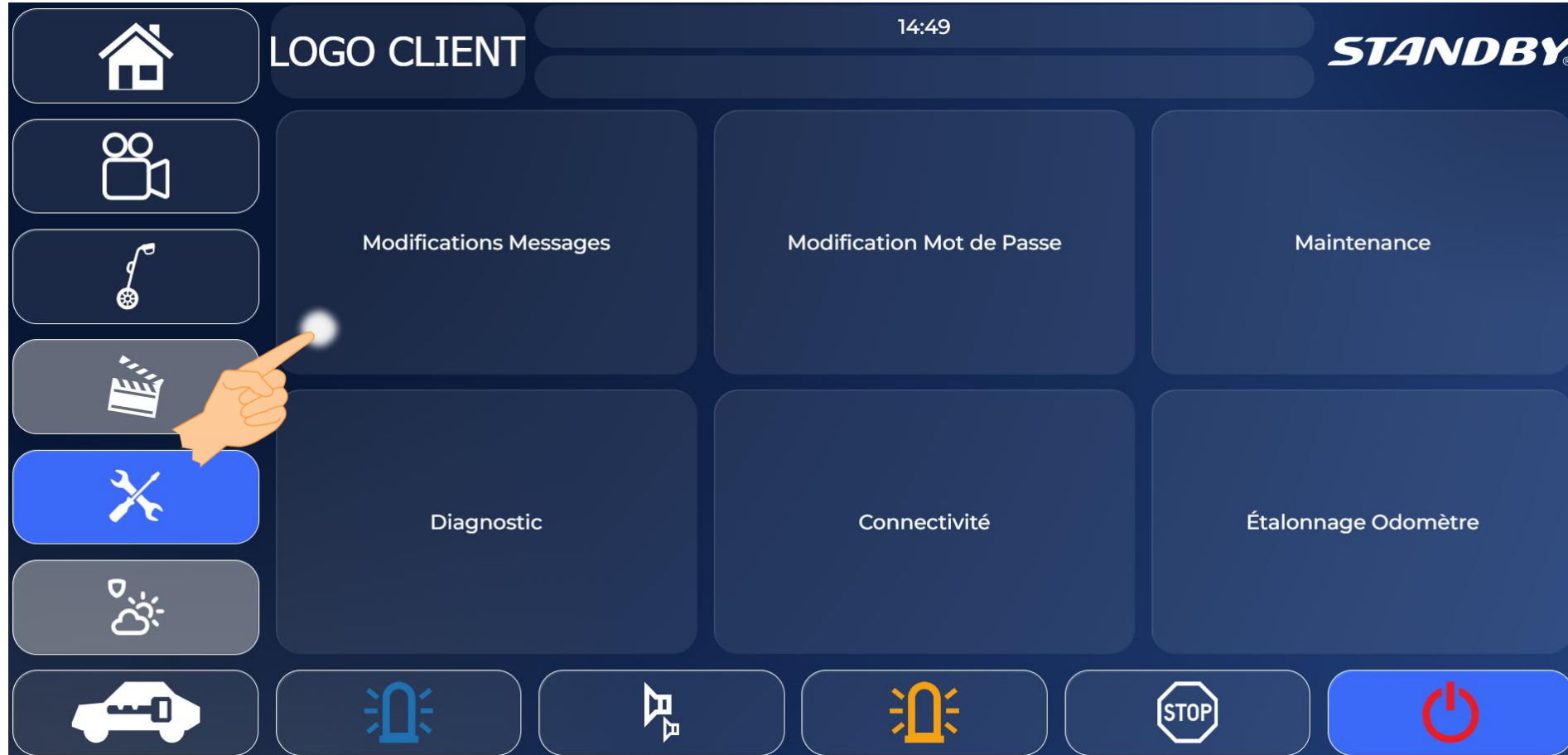

# MODIFICATION MESSAGES



# MENU MODIFICATION MOT DE PASSE

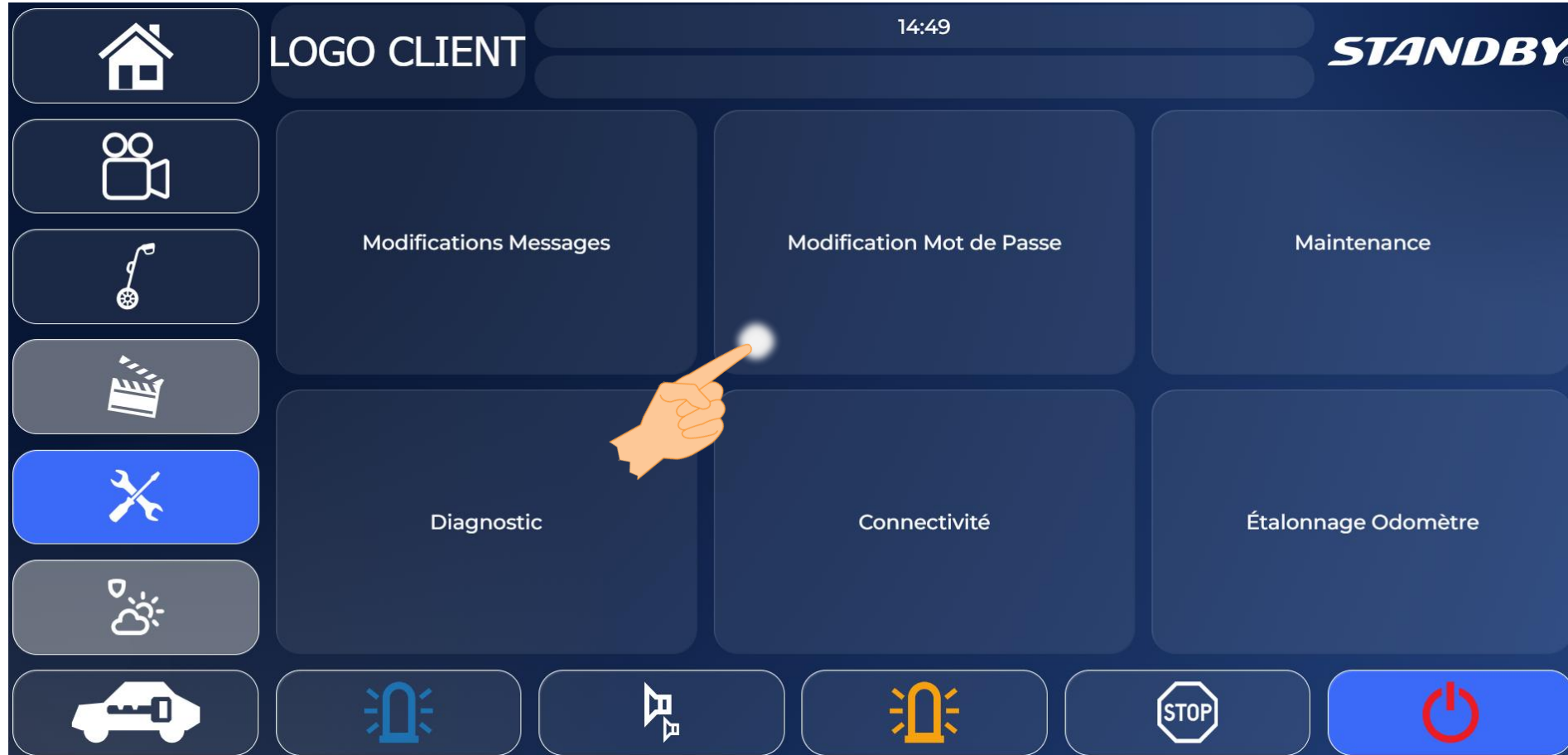

# MODIFICATION MOT DE PASSE

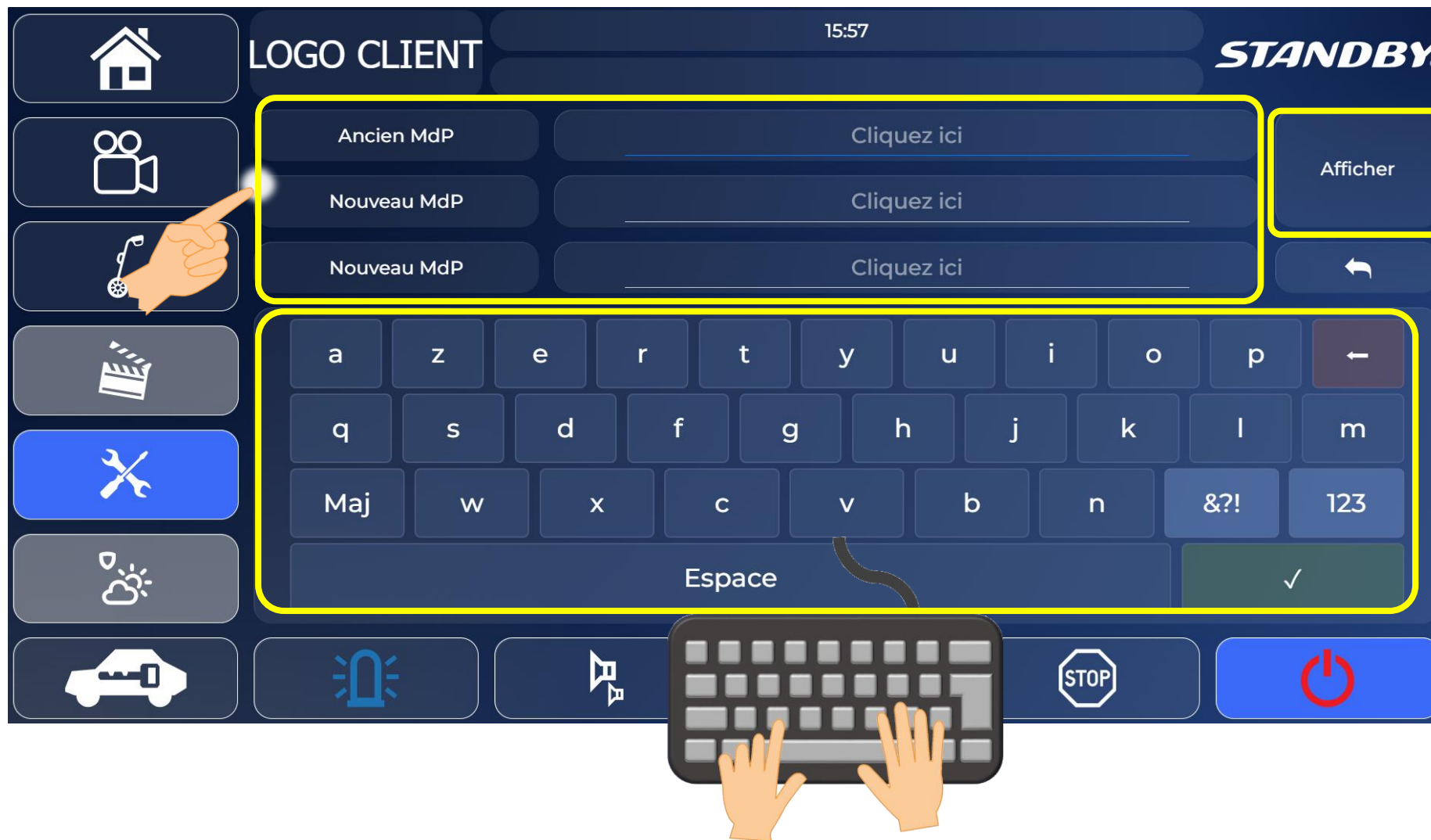

# SELECTION MENU MAINTENANCE



# REGLAGES SEUILS ET NOMBRE MESSAGES

The screenshot displays the STANDBY control interface with the following elements:

- Top Bar:** Home icon, "LOGO CLIENT", time "14:54", and the "STANDBY" logo.
- Left Navigation:** A vertical list of icons: Home, Video, Music, Clapperboard (highlighted with a hand icon), Weather, and Car.
- Settings Panels:**
  - Seuil Vent FLU:** A panel with a yellow double-headed arrow indicating a range from 49 to 51 km/h, with the current value set to 50 km/h.
  - Seuil Vent Triangle:** A panel with a yellow double-headed arrow indicating a range from 49 to 51 km/h, with the current value set to 50 km/h.
  - Max Message PMV:** A panel with a yellow double-headed arrow indicating a range from 99 to 101, with the current value set to 100.
- Bottom Bar:** A row of control buttons: Car, Blue bell, Flag, Yellow bell, "STOP" sign, and a red power button.

# REGLAGES TEMPORISATIONS ET BIP

The screenshot displays the STANDBY control interface. At the top, it shows 'LOGO CLIENT', the time '14:57', and the 'STANDBY' logo. A vertical sidebar on the left contains icons for Home, Video, Music, Clapperboard, Tools (highlighted in blue), Alarm, and Car. The main area contains three settings:

- Tempo Veille Système:** Set to 0 h 0 min. A yellow double-headed arrow indicates it can be adjusted.
- Tempo Arrêt Système:** Set to 0 h 0 min. A yellow double-headed arrow indicates it can be adjusted.
- BIP Alarme:** Set to OFF. A yellow double-headed arrow indicates it can be toggled to ON.

At the bottom, there is a row of control buttons: a blue alarm bell icon, a white alarm bell icon, a yellow alarm bell icon, a white 'STOP' sign icon, and a blue power button icon.

# REGLAGES TEMPORISATIONS ET BIP

The screenshot displays the STANDBY control interface. At the top, it shows the time 14:59 and the STANDBY logo. The interface is divided into a left sidebar with icons for Home, Camera, Music, Settings (selected), Weather, and Car. The main area contains three settings cards:

- Portefeuille avec triangle fixe**: A toggle switch currently set to OFF, with a yellow double-headed arrow indicating it can be switched to ON.
- Feux 300 sur FLU**: A toggle switch currently set to ON, with a yellow double-headed arrow indicating it can be switched to OFF.
- Feux 300 sur Triangle**: A toggle switch currently set to OFF, with a yellow double-headed arrow indicating it can be switched to ON.

At the bottom, there is a row of five icons: a blue bell, a speaker, a yellow bell, a STOP sign, and a red power button.

# REGLAGES LANGUE, LISTE MESSAGE, RAZ

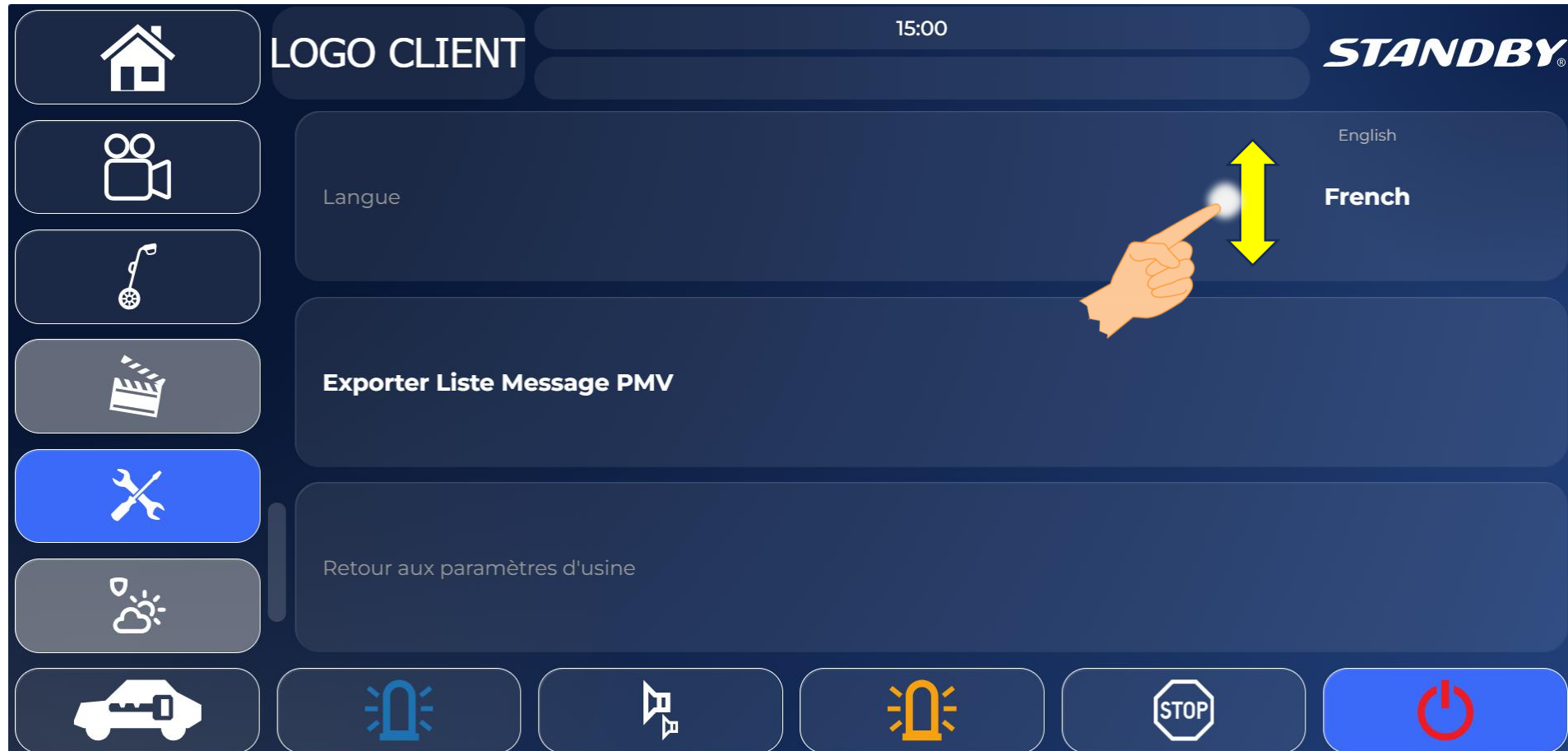

# MENU DIAGNOSTIC

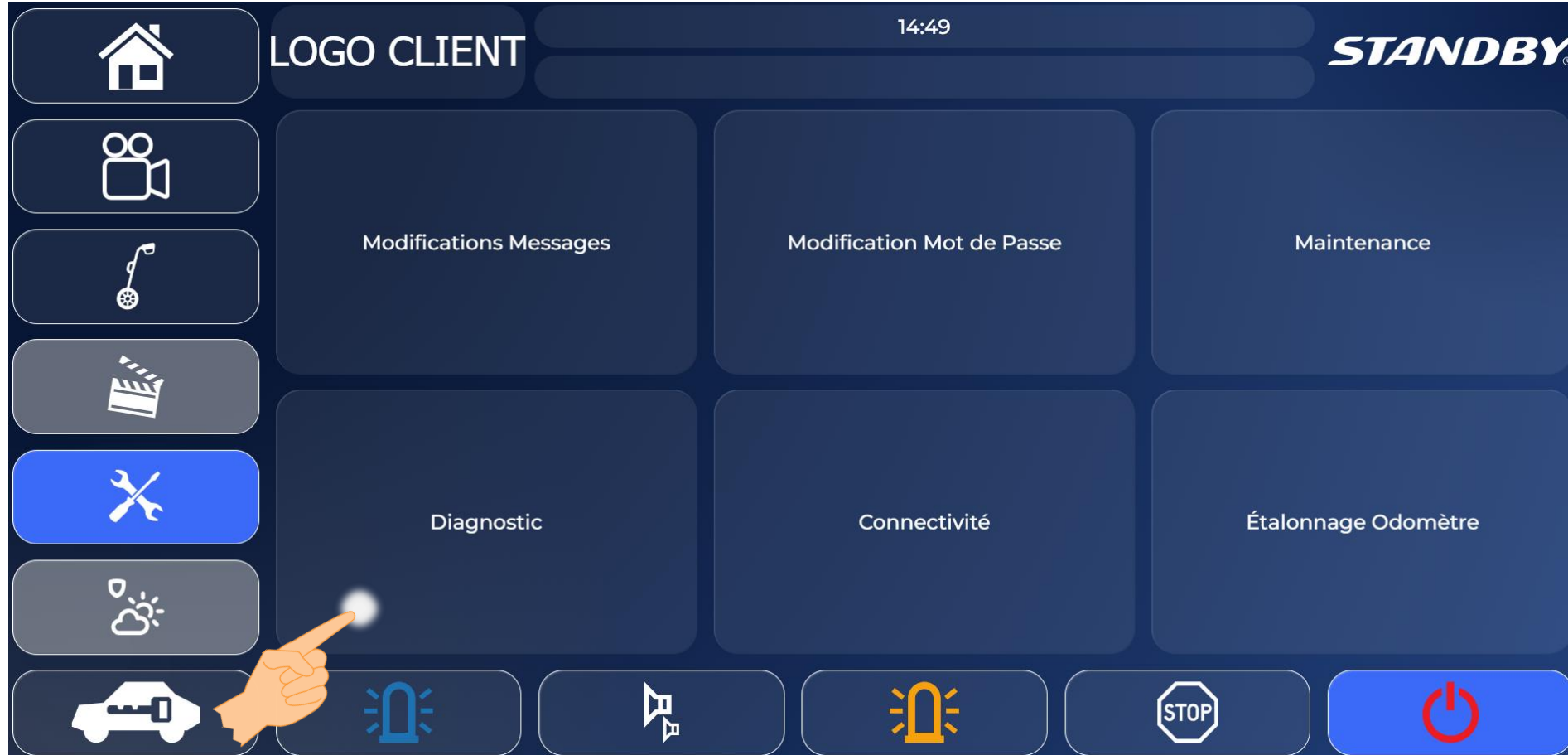

# DIAGNOSTIC RESEAU, MODULES & PARAMÈTRES

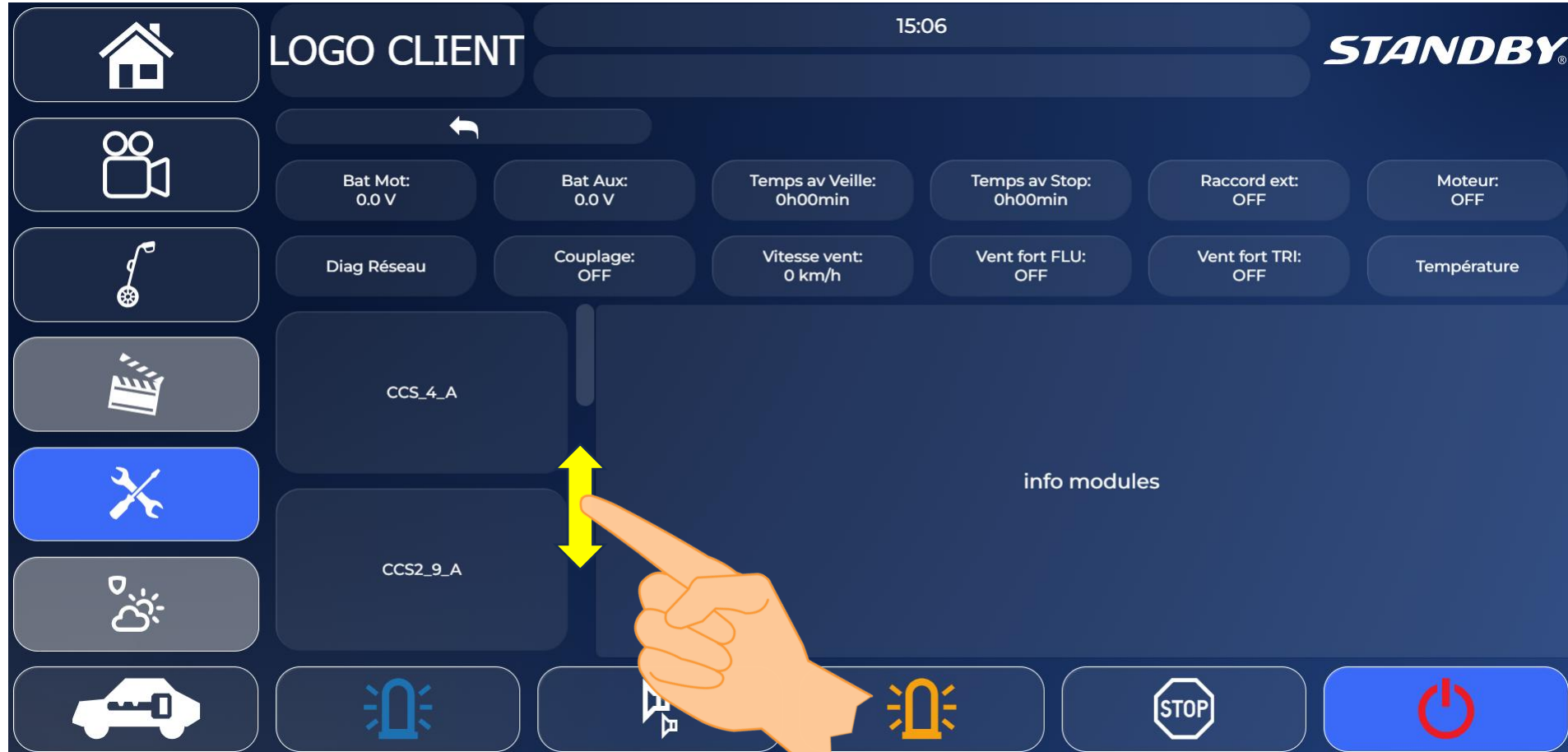

# MENU ETALONNAGE ODOMETRE



# ETALONNAGE ODOMETRE



# PROGRESSION ETALONNAGE ODOMETRE



# MENU STATION METEO



# FONCTION ANTIVOL



# GYROPHARE ORANGE

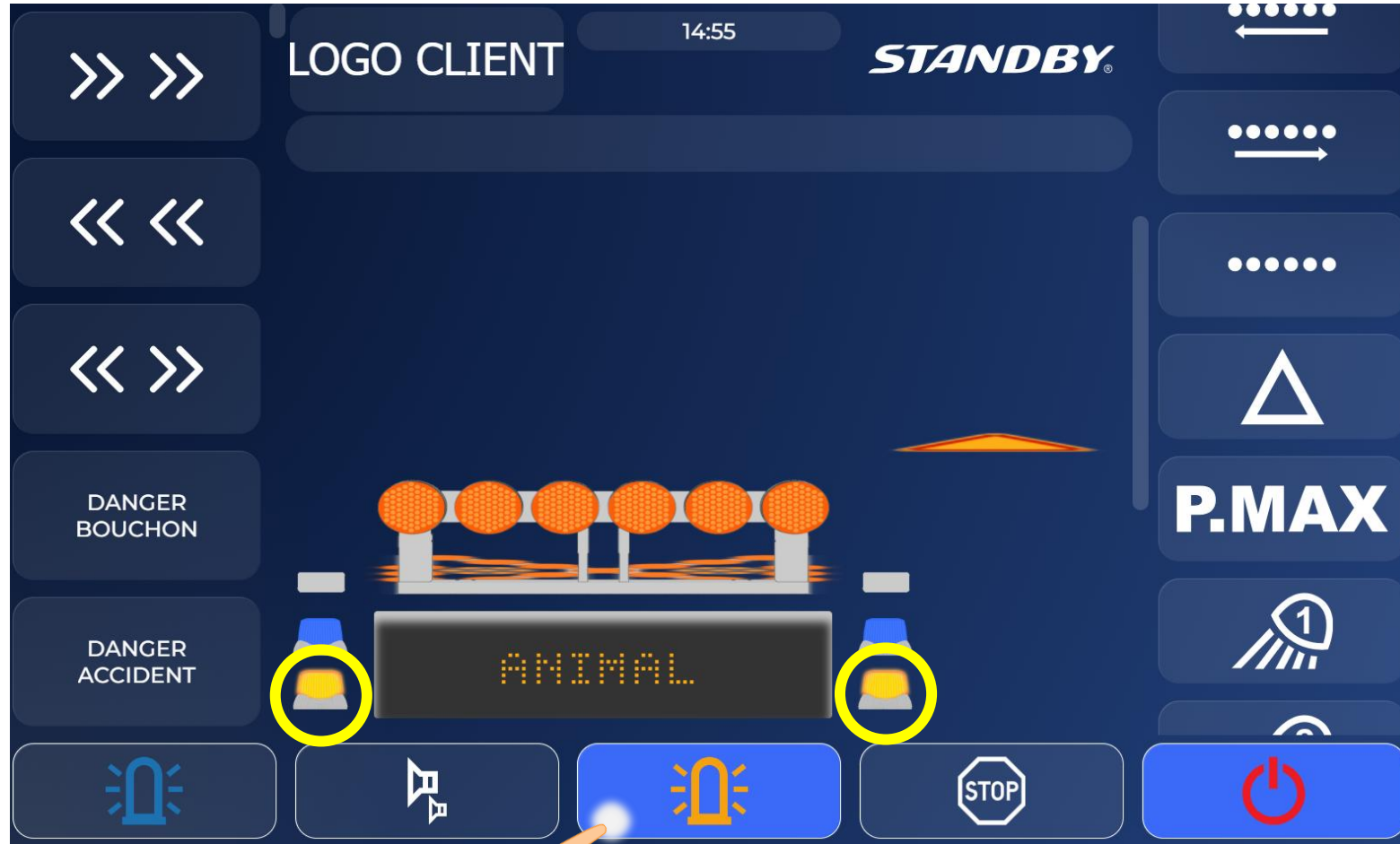

# GYROPHARE BLEU



# SIRENE



# ARRET SIGNALISATION



# MODE AVION



# FLECHE LUMINEUSE D'URGENCE



# DEFILEMENT BARRE KR41



# TRIANGLE



# PROJECTEUR GAUCHE



# PROJECTEUR DROITE



# MESSAGE PMV



**FIN**