

L56 2C

Thank you for choosing a product from Standby.

Technical Data

Lens	Polycarbonate
Diodes	8+8 high power LED
Cable	2 m, basic version
Power	10-30 V DC
Ambient temperature	-40°C to +85°C
Size	140,2 x 50,5 x 20 mm
Approvals	Warning light, class 2: ECE R65 (E5) EMC: ECE R10 (E5) IP67 IP6K9K
Included	1 x L56 Lamp 2C 1 x gasket 1 x assembly kit
Synchronizing	12V: Up to 28 LED Lamps 24V: Up to 14 LED Lamps

Preset Settings

Part number	Color 1	Color 2	Flash pattern		Sync mode	
			Color 1	Color 2	Color 1	Color 2
45657058	Blue	Amber	Double	Double	Simultaneous	Alternate
45657055	Blue	Blue	Double	Double	Simultaneous	Simultaneous
45687078	Amber	White	Double	Steady	Simultaneous	N/A
45677077	White	White	Steady	Steady	N/A	N/A

To change the flash pattern setting, see [Flash Pattern](#). To change the sync mode setting, see [Sync Mode](#).

Flash Pattern

Introduction

The flash pattern setting controls the flash pattern. There are several available combinations of flash patterns, see table.

- **Double, Triple, Quad, Single (1Hz), and Steady burn** are built-in flash patterns and no control system is needed.

The preset setting of flash pattern depends on the version of the lamp, see Preset Settings.

When in configuration mode, the current flash pattern setting is shown in the flash sequence, see table.

Flash pattern		Flash control
Color 1	Color 2	
Double	Double	Built-in
Triple	Triple	Built-in
Quad	Quad	Built-in
Single (1Hz)	Single (1Hz)	Built-in
Steady burn	Steady burn	External

Setting the Flash Pattern

! WARNING

Risk of eye damage. Do not look into the beam at close range.

1. If already in configuration mode, go to step 6.
2. If the lamp is connected to the power supply, disconnect it.
3. Connect the red (color 1)/yellow (color 2) wire to 10-30 V DC via a 5 A fuse.

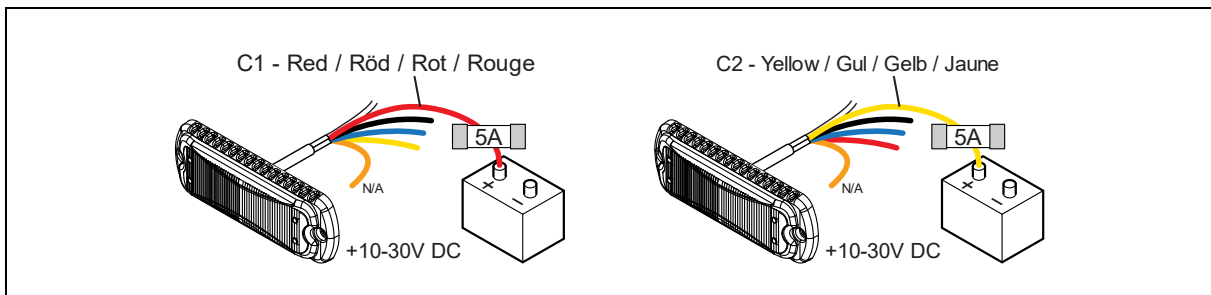

4. Connect the black wire to ground.

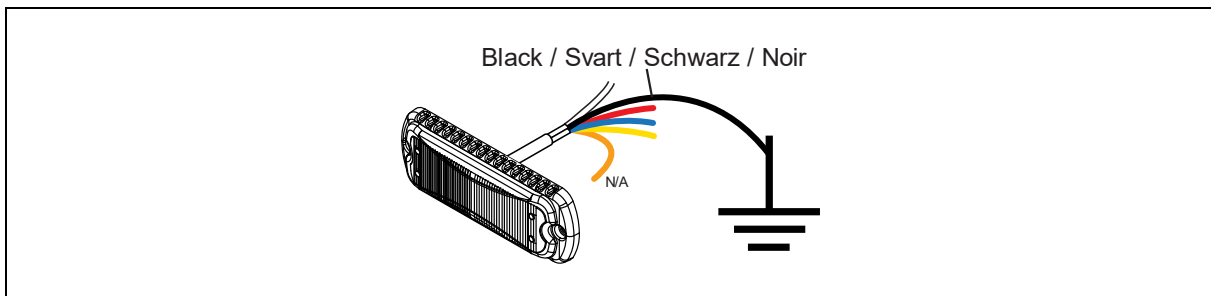

5. Within 1 to 6 sec: temporarily connect the white wire to ground and let it stay connected for at least 2 sec.

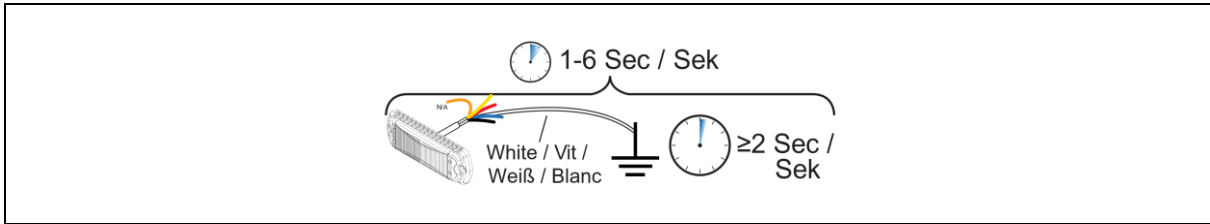

The lamp enters configuration mode and a flash sequence indicating the current settings starts.

! Note

If this step is performed incorrectly, you must restart from step 2.

6. The selected flash pattern is displayed.

7. Temporarily connect the white wire to ground again to change to the next version of flash pattern. Each time the white wire is temporarily connected to ground the next version of flash pattern is selected.

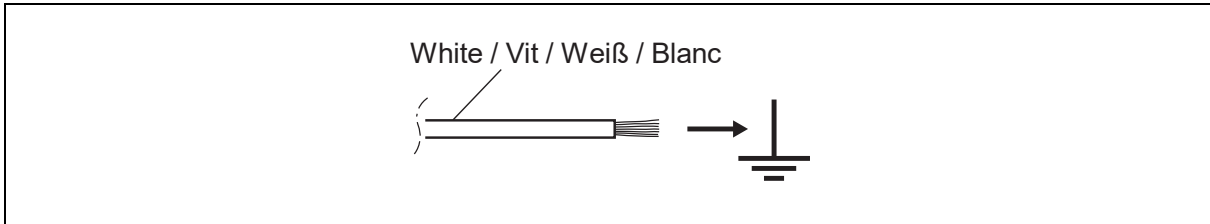

8. To change the sync mode setting, see [Sync Mode](#). To reset to factory settings, see [Factory Reset](#).

9. Disconnect the power supply to save the selected settings and exit configuration mode.

Sync Mode

Introduction

The sync mode setting controls how the flashing of two or more lamps is synchronized. There are two versions of sync mode: Simultaneous and Alternate.

- **Simultaneous** means that the lamps are in sync, that is they come on and go off at the same time.
- **Alternate** means that the lamps are out of sync.

The preset setting of sync mode, see [Preset settings](#).

Slow flash shows simultaneous mode and quick flash shows alternate mode.

Setting the Sync Mode

! WARNING

Risk of eye damage. Do not look into the beam at close range.

1. If already in configuration mode, go to step 6.
2. If the lamp is connected to the power supply, disconnect it.
3. Connect the red (colour 1)/yellow (colour 2) wire to 10-30 V DC via a 5 A fuse.

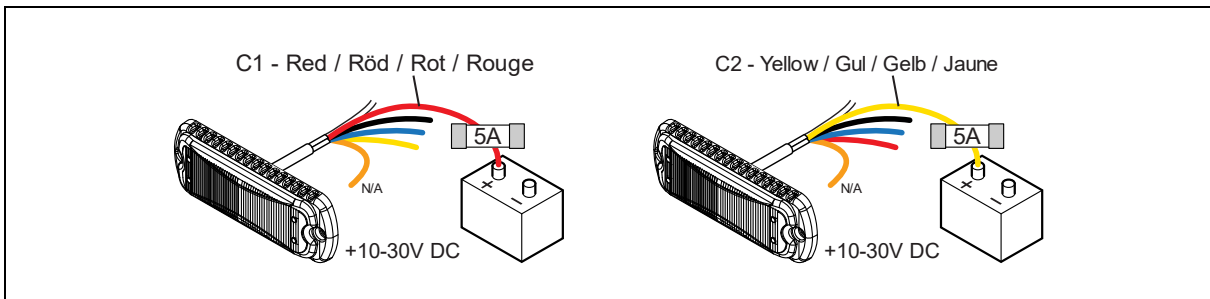

4. Connect the black wire to ground.

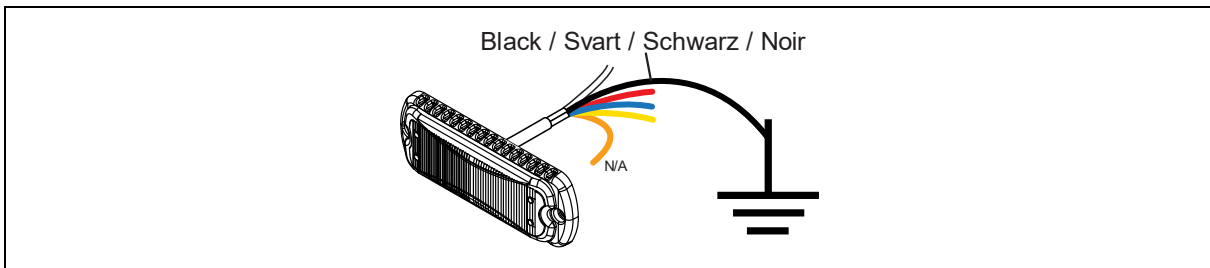

5. Within 1 to 6 sec: temporarily connect the white wire to ground and let it stay connected for at least 2 sec.

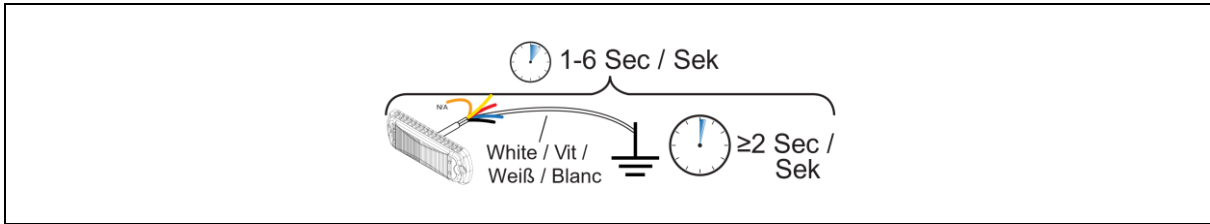

The lamp enters configuration mode and a flash sequence indicating the current settings starts.

! Note

If this step is performed incorrectly, you must restart from step 2.

6. Temporarily connect the blue wire to plus to change to the next version of sync mode. Each time the blue wire is temporarily connected to plus the next version of sync mode is selected. Slow flash shows simultaneous mode and quick flash shows alternate mode.

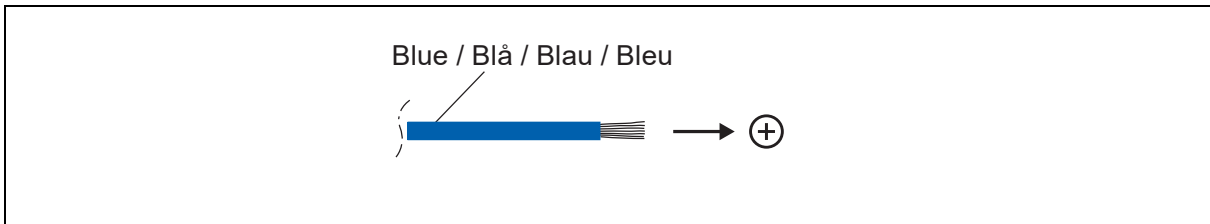

8. To change the flash pattern setting, see [Flash Pattern](#). To reset to factory settings, see [Factory Reset](#).

9. Disconnect the power supply to save the selected settings and exit configuration mode.

Factory Reset

Introduction

The settings can be changed back to the factory settings.

The factory settings are like the Preset settings.

Reset to Factory Settings

! WARNING

Risk of eye damage. Do not look into the beam at close range.

! Note

All current settings, that is both flash pattern setting and sync mode setting, are reset to the default settings.

1. If already in configuration mode, go to step 6.
2. If the lamp is connected to the power supply, disconnect it.
3. Connect the red wire to 10-30 V DC via a 5 A fuse.

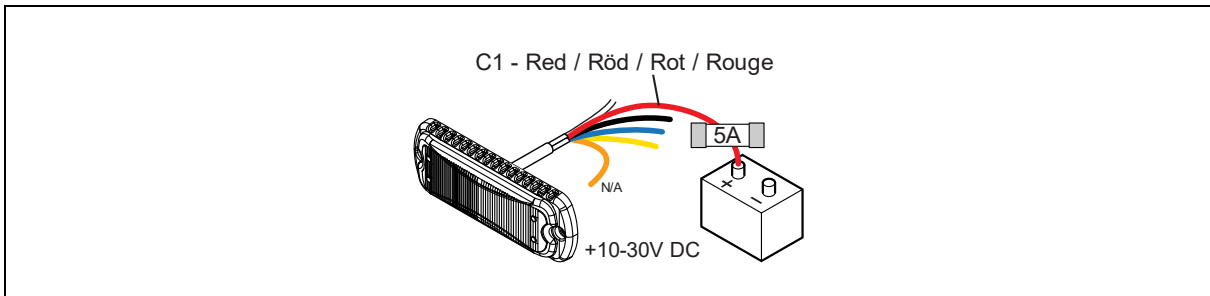

4. Connect the black wire to ground.

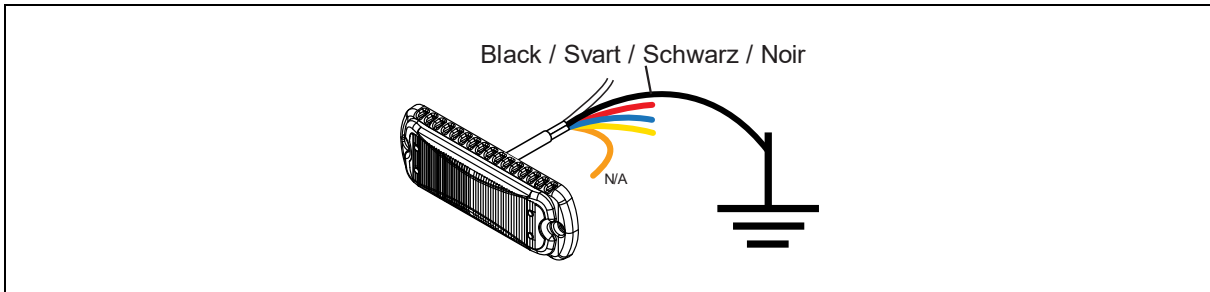

5. Within 1 to 6 sec: temporarily connect the white wire to ground and let it stay connected for at least 2 sec.

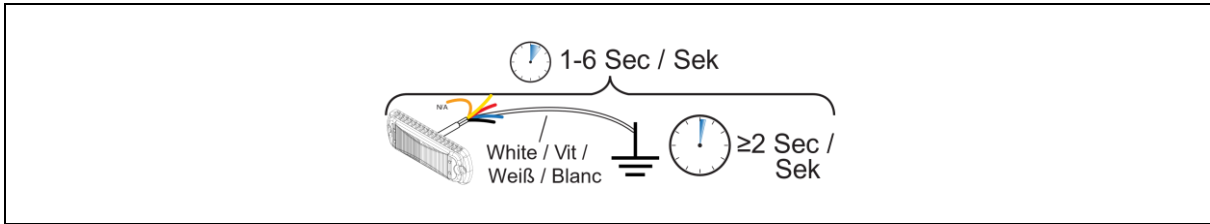

The lamp enters configuration mode and a flash sequence indicating the current settings starts.

! Note

If this step is performed incorrectly, you must restart from step 2.

6. Fast temporarily connect the **YELLOW** wire to 10-30 V DC to enter the configuration mode for factory reset. A quick pulsating light indicates that the lamp has been changed from factory settings, slow pulsating light indicates that settings are according to the factory settings.

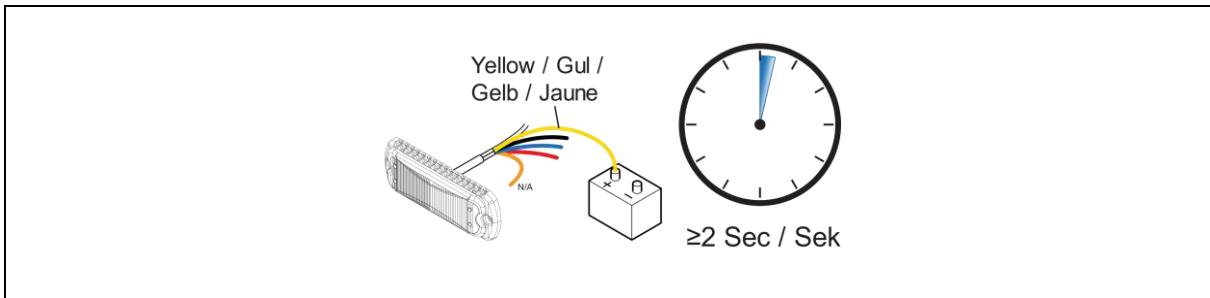

7. The reset is confirmed with a bright flash light for 2-3 seconds.

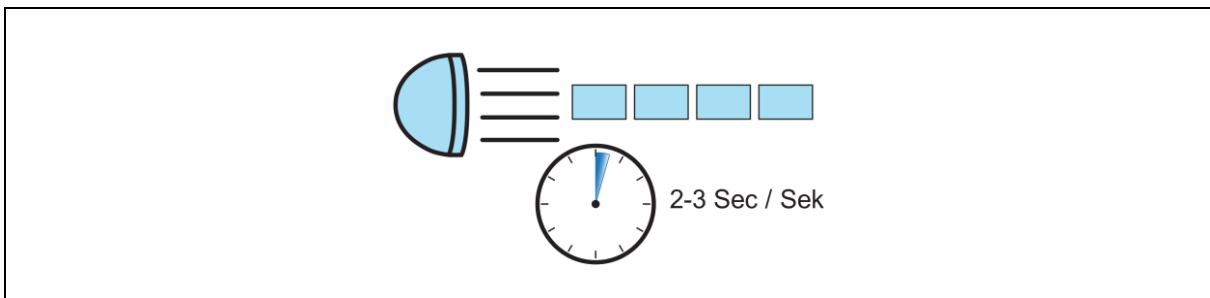

Connections

The function of each wire and how to connect the wires depend on which version of flash pattern that is selected, see tables below.

Table 1. Connections when flash pattern Double or Steady burn is selected.

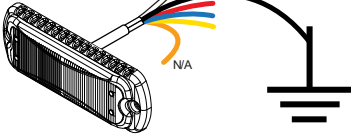
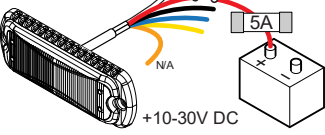
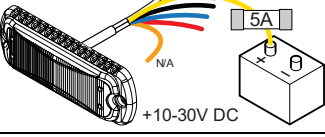
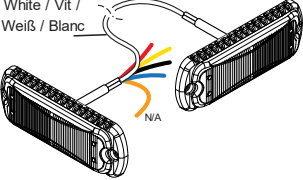
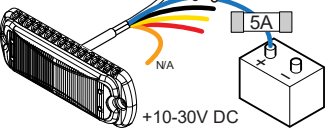
Wire	Functions	Connect to	
Black	Power supply	Good and suitable ground	<p>Black / Svart / Schwarz / Noir</p> 
Red	Power supply / color 1	10-30 V DC via a 5 A fuse	<p>C1 - Red / Röd / Rot / Rouge</p> 
Yellow	Power supply / color 2	10-30 V DC via a 5 A fuse	<p>C2 - Yellow / Gul / Gelb / Jaune</p> 
White	Sync cable	Other lamps	<p>White / Vit / Weiß / Blanc</p> 
Blue	Day/Night	10-30 V DC via a 5 A fuse	<p>Blue / Blå / Blau / Bleu</p> 

Installation

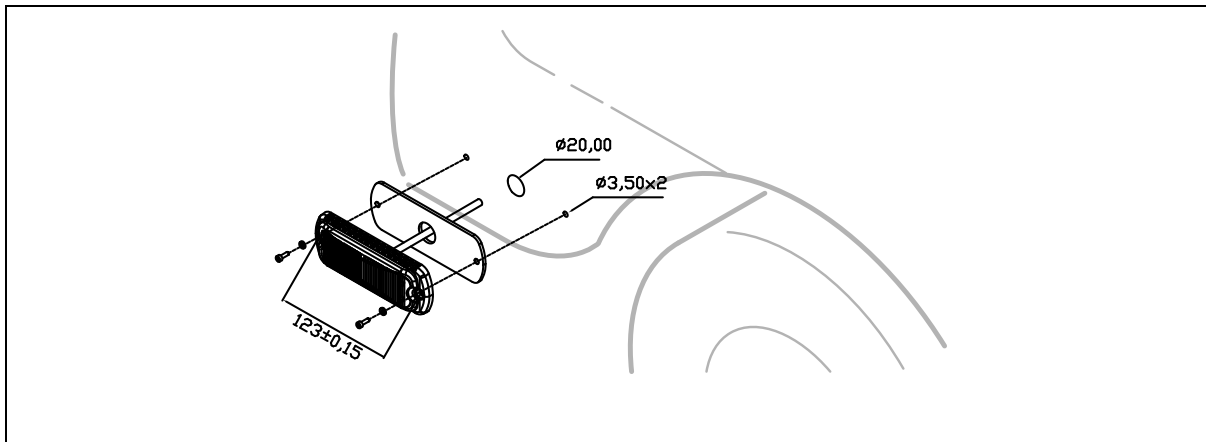

! CAUTION

The lamp must be mounted on a flat surface.

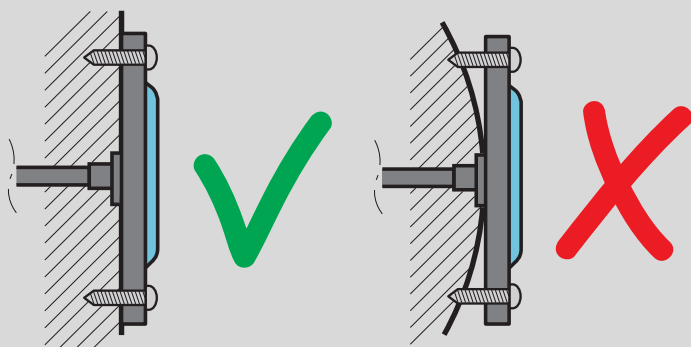

To prevent moisture from entering the lamp through the cable end, make sure that the cable end is sealed or located in a dry part of the vehicle.

When using a pressure washer, keep a minimum distance of 40 cm.

