

# Trail Blazer 2



## FEATURES

- **DEKRA:** Speed rated 124mph (200kph) both Magnetic & Vacuum Cup mounted, *includes adjustable safety lanyard.*
- **3-year Warranty** (integrated speaker has 1-year).
- **New digital built-in Speaker amplifier:** Standard 60w integral speaker (106.3 dB @ 7 metres).
- **Flash Pattern:** Double 2Hz
- **Front Takedown Lights:** Flashing.
- **Rear Reds:** Flashing Reds for Arrival at Scene.
- **Weight:** 5.8Kg (12.8lb)

## Handset

- Illuminated handset button as standard.
- Handset button brightens when active – to indicate LED's are active in daylight use.
- Large multi-functional single Start/Stop & Siren Tone change button to eliminate fumbling. Press once to start, press again to change siren tone & double press quickly to stop siren.
- Multi-function pre-programmed buttons, standard configurations are shown by product code.

## DIMENSIONS - Mag Mounted

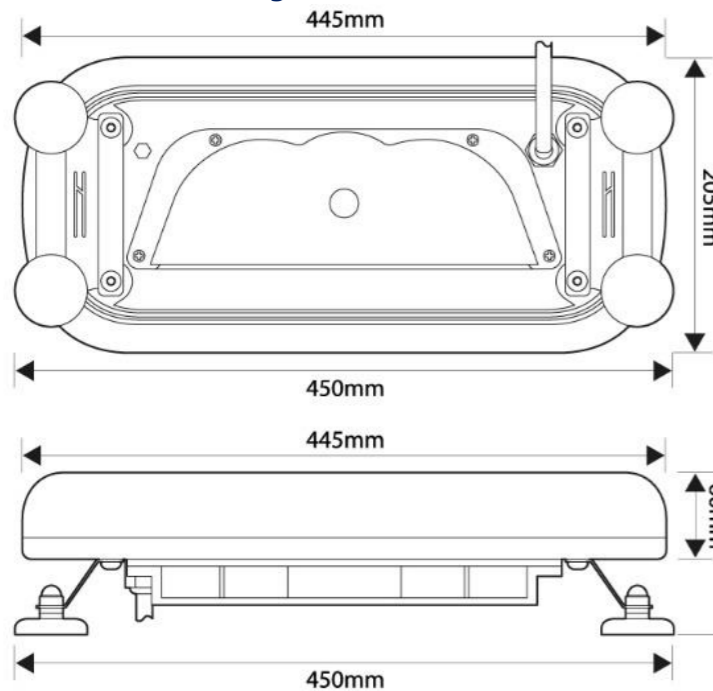

The light bar will operate via the vehicle's standard cigarette lighter socket. Should you choose to wire the lightbar directly to the vehicle battery ensure the system is fused accordingly (10 Amps) and via a suitable two-part connector if required. On some vehicles, the cigarette lighter socket is switched via the ignition switch, which may cause some operational difficulties.

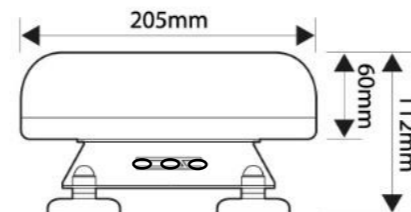

## SPECIFICATIONS

**Approvals:**  
ECE R10; DEKRA

**Operating Voltage:**  
12vDC – Standard Cigarette Lighter Socket with 5-metre Flat Cable

*Comes with Carry Case as standard.*

## Product code

**TB2-TB18C-22M21** – Trail Blazer 2 w/Mag Mtg  
**TB2-TB18C-22V21** – Trail Blazer 2 w/Vacuum Cup Mtg

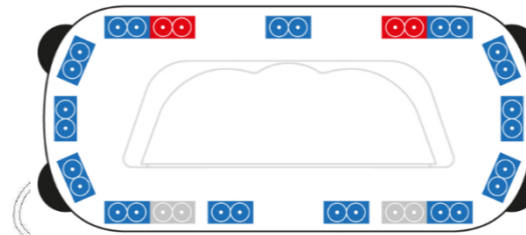

## Trail Blazer 2 (Clear Lens)

- 999 mode + GATSO
- Siren Tones Toggle
- 360° Blues
- Front Flashing Spots
- Rear Flashing Reds
- Low Power
- Clear All



## Product code

**TB2-TB18C-22M61** – Trail Blazer 2 w/Mag Mtg  
**TB2-TB18C-22V61** – Trail Blazer 2 w/Vacuum Cup Mtg

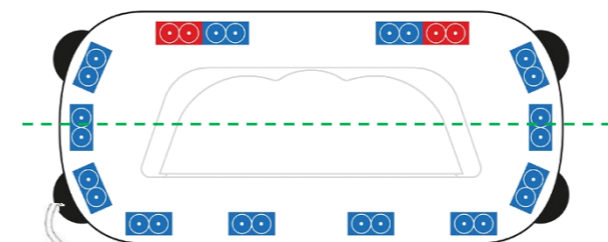

## Trail Blazer 2 (Clear Lens)

- Siren On/Off & Tone Toggle
- 999 360° Blues only
- At Scene – Rear Blues/Reds only (Green Line) & Cancel Siren
- Cancel All

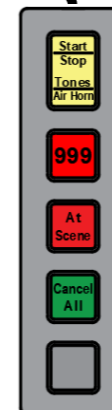

## Product code

**TB2-TB18B-22M11** – Trail Blazer 2 w/Mag Mtg  
**TB2-TB18B-22V11** – Trail Blazer 2 w/Vacuum Cup Mtg

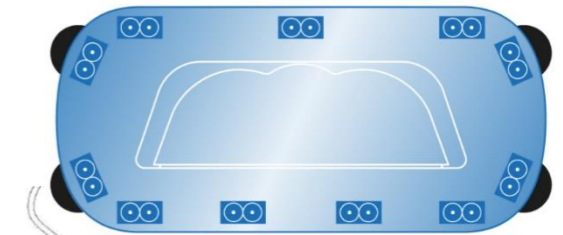

## Trail Blazer 2 (Blue Lens)

- 999 mode + GATSO
- Siren Tones Toggle
- 360° Blues
- Low Power
- Clear All



## Product code

**TB2-TB18C-22M51** – Trail Blazer 2 w/Mag Mtg  
**TB2-TB18C-22V51** – Trail Blazer 2 w/Vacuum Cup Mtg

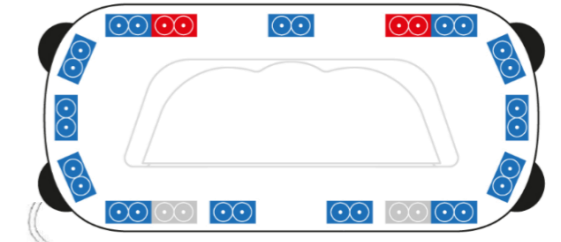

## Trail Blazer 2 (Clear Lens)

- Siren On/Off & Tone Toggle
- 999 360° Blues side-by-side + GATSO
- Arrive Scene - 360° Blues & Reds
- Front Spots/Whites
- Rear Red/Blue
- Low Power
- Cancel All



## DIMENSIONS – Vacuum Cup Mounted

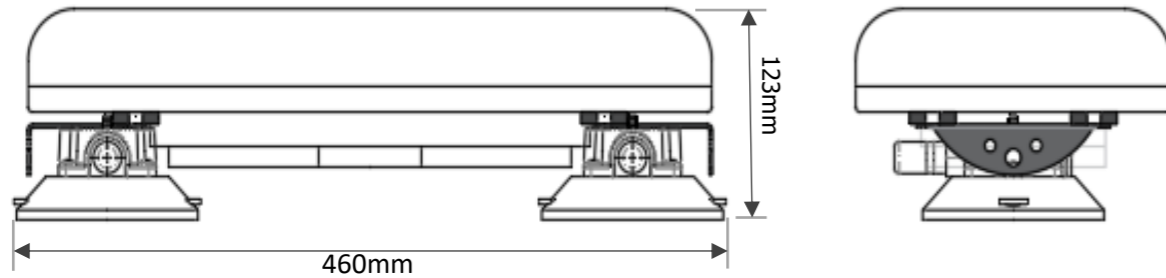

**1:** Clean vehicle roof area using an alcoholic wipe to remove any dirt/grease.

**2:** Remove protective cover from Vacuum Cup and wipe free any dust using a damp cloth.  
*Always ensure to replace protective covers on Vacuum Cups when not in use.*

**3:** Carefully position Trail Blazer 2 on the roof of the vehicle. Vacuum Cup against Vehicle Glass and push slightly to create seal.

**Mounting Guidelines Magnetic:** When mounting the lightbar onto a vehicle roof, ensure that both the roof and the unit bases are clean. Some vehicle bodywork style features can inhibit the magnets ability to align on the roof (reducing magnetic adhesion). Therefore, the light bar must be positioned on a flat metal section of the roof. The unit's adhesion should be checked before commencing each journey and the lanyard must always be fitted. Dependent on the height of the vehicle, additional equipment (such as step ladders) may be required to place/remove product.

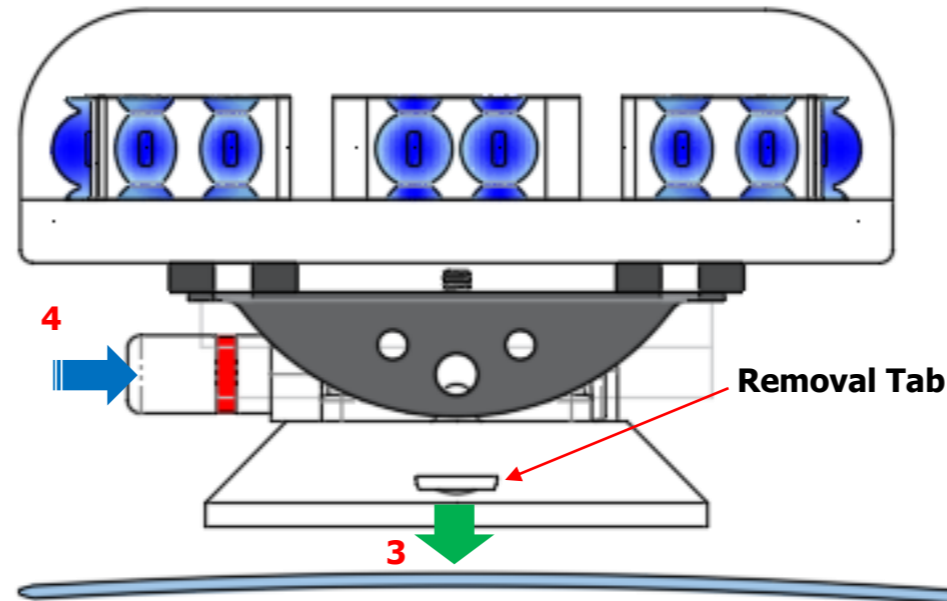

**4:** Push the pump plunger to the rear of the unit so the red line is no longer visible, this has now created the required vacuum seal in the unit. Fix lanyard following guidelines below.

**5:** *It is imperative that the Vacuum Seal is checked before any journey and at regular intervals, to ensure red line remains hidden, if necessary, repeat step 4.*

Should the red line appear regularly then refer to Vacuum Cup maintenance leaflet for further details.

[Vacuum Cup GUIDE - Maintenance/Troubleshooting & Repair.pdf](#)

Unscrew counterclockwise to release, slide Ball Up/Down to position then screw clockwise to secure.

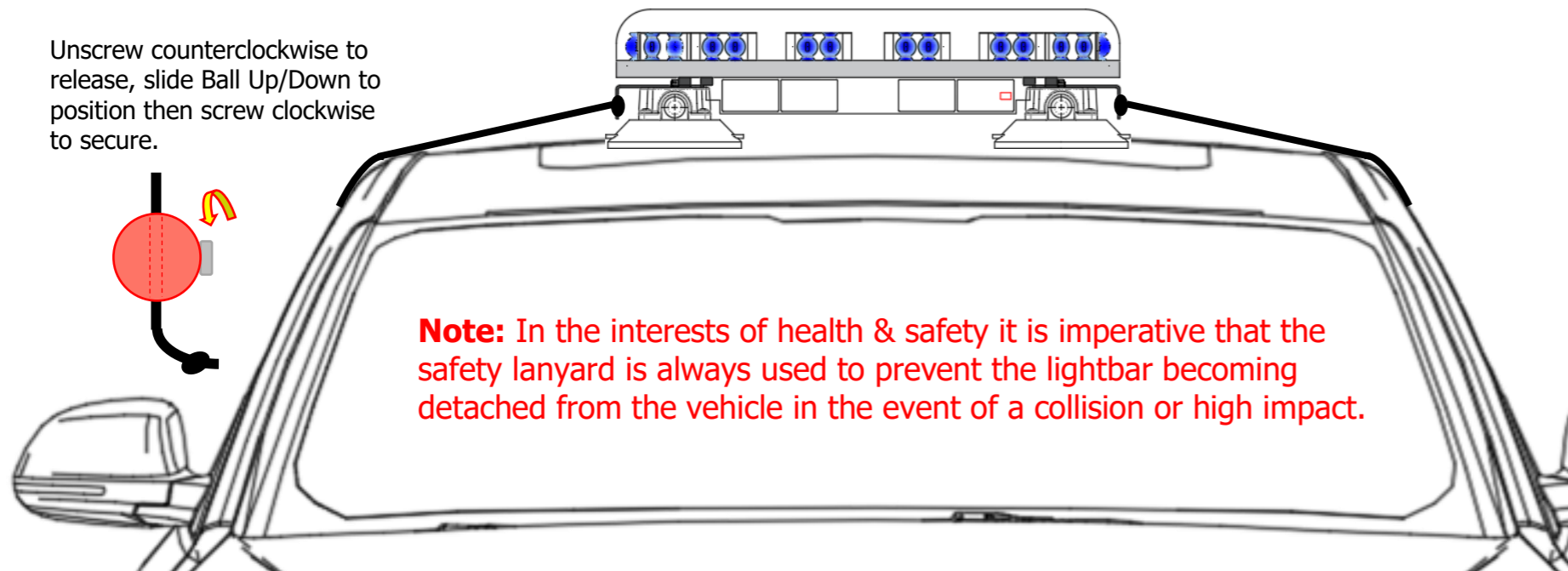

**Note:** *In the interests of health & safety it is imperative that the safety lanyard is always used to prevent the lightbar becoming detached from the vehicle in the event of a collision or high impact.*

**Removal Guidelines:** Firstly, the lanyard should be loosened and removed from the door.

**Vacuum Cup Version** – carefully lift 1 of 3 tabs on the suction cup releasing the vacuum. If this is not done the vacuum may cause the bases to detach from their mounting plates causing damage to the cup. Lift the unit in a smooth motion.

**Magnetic Version** – To remove the unit, lift in a smooth motion ideally one magnet at a time. Once the magnets are away from the vehicle roof the light bar should be lifted off. At no time should the light bar be dragged across the vehicle roof.