

6-way Mini Stealth (MS6BS) Rubber Boot manual

1. Use template to mark mounting hole, and drill accordingly. (dimensions in mm)

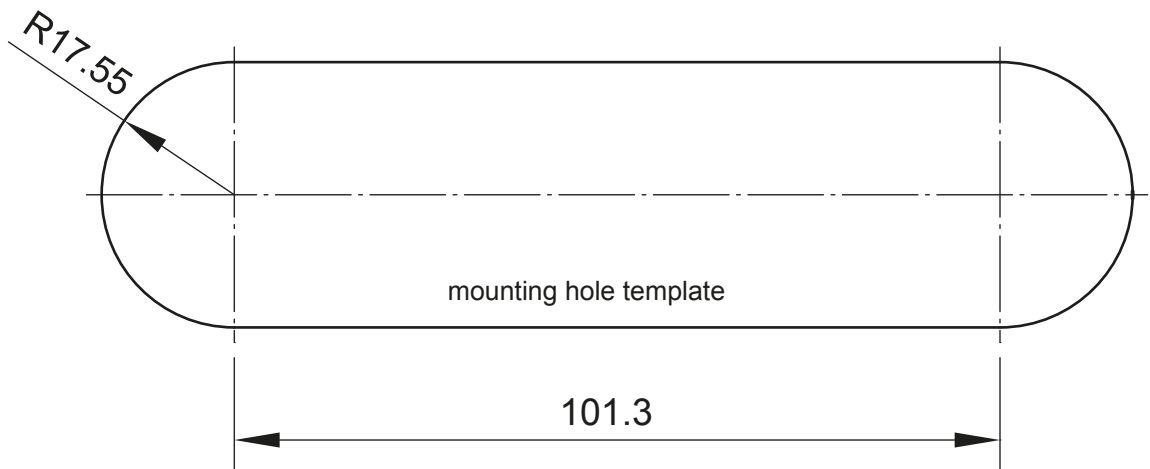

2. Insert lighthouse to rubber boot, and secure lighthouse with supplied screws.

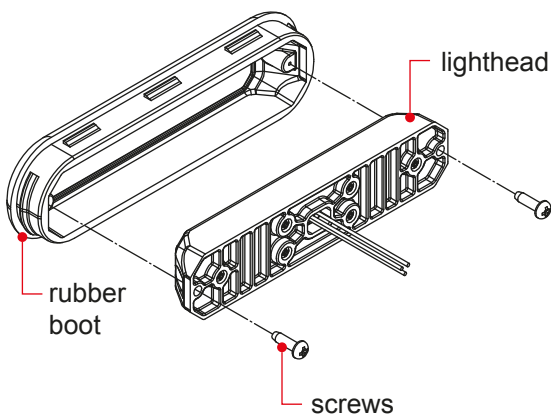

NOTE: Do not over-tighten the screws.

3. Insert assembled rubber boot into mounting hole, and ensure that it is leveled with the mounting surface.

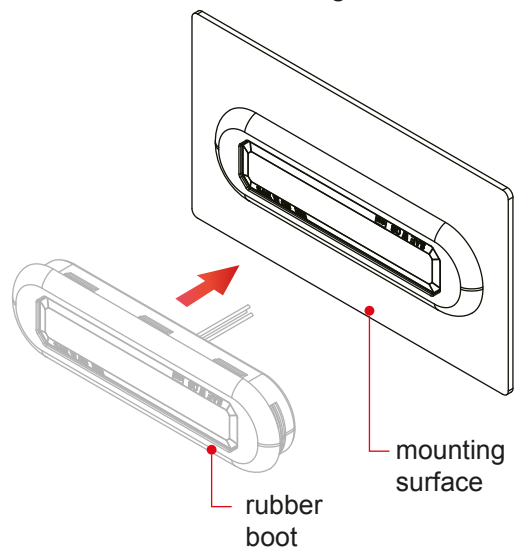

WARNING: When inserting into mounting hole, exert force only on the rubber boot.