

LIGHTING, CONTROLLERS, TELEMATICS, CCTV

Leading the way in road safety

Standby RSG are one of the UK's leading suppliers of response and emergency vehicle hazard lighting, warning & control systems and video telematics solutions.



STANDBY
RSG



Lightbars

Choose from a range of lightbars including mini lightbars

2-4



Warning Lights

Be conspicuous or discreet with a range of external, internal and covert LED warning lights

5-7



Traffic Commander

Programmable LED Matrix Displays

8



Control Units

User programmable control devices for managing hazard warning functions

9-12



Sirens & Speakers

Digital and electronic siren amplifiers and compatible loudspeakers

13-14



Switch Units

A versatile range of fully programmable handsets and switch units

15-16



FleetMotus Telematics Devices

Vehicle utilisation and driver behaviour monitoring tools

17-18



AutoEye Xpert Vehicle Video Systems

Modular multi-channel vehicle video solutions

19-21



CARAT Switch System

An innovative solution to improve in-car switching technology

22

Lightbars

LEGION LED LIGHTBAR

The Legion lightbar is a tried and tested model that is powerful in performance yet economically priced.

A clear, UV stable, multi-section shell wraps around a sturdy aluminium extrusion resulting in a lightweight, modular and easy to service rooftop lighting option.

- Clear multi-sectional lenses, blue lenses available to order
- Available from 24 to 49 inches, longer lengths also available
- Optional alley lights, take downs and GATSO
- Optional illuminated centre section or built-in 100w speaker
- Dimmed light and cruise function
- 12 volt operation only
- 5 year warranty
- ECE R65 Class 2, ECE R10 and Spec 5 certified



AEGIS LED LIGHTBAR

The Aegis LED lightbar has separate sectional UV stable polycarbonate lenses. Top lenses are available in a range of designated colours while the base lenses are crystal clear allowing 360° visibility of the intense D-fuser LEDs.

The Aegis is the ideal choice if you want to stand out from the crowd and make your presence known.

- Available from 42 to 54 inches in length as standard with 72" available to order
- Optional side alley lights, take downs, GATSO and traffic director function
- Optional illuminated centre section or built-in 100w speaker
- Dimmed light and cruise function
- 12 or 24 volt operation
- 5 year warranty
- ECE R65 Class 2 and ECE R10 approved



W3 LED LIGHTBAR

This top of the range lightbar has a robust, aerodynamic design with single or dual colour interior modules in blue, amber, white and red - offering a whole host of possibilities.

The W3 was developed to cope with the tough Nordic climate and is built with high quality in mind. The lightbar is connected via CAN-Bus or via a separately purchased break-out box.

- Aerodynamic design that provides minimal air resistance and low noise
- Multiple lengths available from 37 to 76 inches
- Optional work lights, running lights, indicators and/or brake lights
- Side alley lights as standard
- Dimmed light and cruise function
- 12/24 volt operation
- 4 year warranty
- ECE R65 Class 2 and ECE R10 approved



SEE WEBSITE FOR FULL PRODUCT RANGE

EXTENDED WARRANTIES AVAILABLE

Lightbars

VEGA LED LIGHTBAR

This robust intermediate lightbar has a solid aluminium structure with UV stable polycarbonate lenses in blue, clear or amber. It houses high intensity single colour interior modules in blue or amber.

This lightbar is available as a video enabled version incorporating built-in cameras that are compatible with the AutoEye Xpert range of vehicle video equipment.

- Aerodynamic styling provides minimal air resistance and low noise
- Available from 33 to 63 inches in length
- Supplied with adjustable mounting brackets
- Dimmed light and cruise function
- 12/24 volt operation
- 3 year warranty
- ECE R65 Class 1 and ECE R10 approved



SILVERBLADE LED LIGHTBAR

At only 43mm high the Silverblade is one of the lowest profile premium lightbars available. Packed with latest generation single or dual colour LED light heads.

Its streamlined design with crystal clear, UV stable, polycarbonate lenses that have one single join at the centre make the Silverblade an attractive, durable and uncluttered choice.

- Sleek ultra low profile
- Available from 44 to 54 inches in length
- Built in traffic director
- Optional side alley lights, take downs and GATSO
- Dimmed light and cruise function
- 12 volt operation only
- 5 year warranty
- ECE R65 Class 2 and ECE R10 approved



HURRICANE LED LIGHTBAR

The Hurricane LED Lightbar is a cost effective, slimline unit with high quality, UV stabilised polycarbonate lenses in clear, amber and new transient blue.

Transient blue lenses allow white and red light to shine through without being affected by its colour whilst also maintaining ECE R65 Class 1 status.

- Available 42 inches as standard, other lengths available to order
- Optional alley lights, takedowns and GATSO
- Supplied with rubber mounting feet
- 12 and 24 volt operation
- 3 year warranty
- ECE R65 Class 1 and ECE R10 approved



RAIDEN LED LIGHTBAR

The Raiden LED lightbar has a sleek, slimline design with powerful wide angle optics for 360° warning coverage.

This contemporary lightbar is fully programmable with a built-in ambient light sensor and plug-n-play CAN bus control box. It has single colour or multi-functional dual colour LED modules set behind clear or coloured polycarbonate lenses.

- Available from 42 to 72 inches long
- Optional side alley lights, take downs, stop tail turn, GATSO and traffic director function
- Dimmed light and cruise facility
- 12/24 volt operation
- 5 year warranty
- ECE R65 Class 2 and ECE R10 approved



SEE WEBSITE FOR FULL PRODUCT RANGE

EXTENDED WARRANTIES AVAILABLE

Mini Lightbars

TRAIL BLAZER 2 MINI LIGHTBAR & DIGITAL SIREN

The Trail Blazer 2 incorporates state-of-the-art LED's, digital siren technology and strong magnets/vacuum cups as well as being fully type approved to ECE R10 and DEKRA speed tested to 124 mph (200kph).

The integral multi-tone digital siren has a power rating of 60 watts, but has a dB sound rating equivalent to 80 watts. Three siren tones are projected through an unobtrusive, low profile speaker positioned on the underside of the lightbar.

Super bright LED's including a Gatso module are set to the rear, front and corners of the lightbar creating a full 360° light output.

Illuminated handset controllers offer reliable direct control of the lighting and siren features.

- Super strong magnetic or vacuum mount DEKRA speed tested to 124mph (200kph)
- 3 siren tones - Yelp/Wail, Hi/Lo and Air Horn
- Built-in flash pattern - Double 2Hz left/right split
- Pre-programmed illuminated handset controller
- Available with clear or blue lenses
- 3 year warranty (lightbar only)
- 12 volt operation only
- ECE R10 approved

Dimensions:

60mm (h) x 445mm (w) x 205mm (d)
(not including mounting option)



Vacuum Mount



Magnetic Mount

DIAMONDBACK MINI LED LIGHTBAR

A compact yet powerful warning solution that offers the flexibility of either permanent bolt fix or vacuum magnetic mounting complete with cigar plug connector.

- Aerodynamic styling minimises air resistance reducing drag
- Crystal clear, UV stable polycarbonate lenses
- Low power function for night time use
- 23 built-in flash patterns
- 12 and 24 volt operation
- 5 year warranty
- ECE R65 Class 1 and ECE R10 approved

Dimensions:

53mm (h) x 355mm (w) x 205mm (d)



MICROBAR-EX LED MINI LIGHTBAR

The microbar-EX is a compact, low profile mini LED lightbar that houses 14 LED modules totalling 42 super bright, LEDs rated to 100,000 hours of operation.

Flexible mounting options offer permanent bolt fix or magnetic mounting complete with multi-function cigar plug connector.

- Low profile UV stable polycarbonate lenses
- Low power function for night time use
- 24 built-in flash patterns
- 12 and 24 volt operation
- 5 year warranty
- ECE R65 Class 1 and ECE R10 approved

Dimensions:

37mm (h) x 400mm (w) x 172mm (d)



Magnetic Mount

SEE WEBSITE FOR FULL PRODUCT RANGE

EXTENDED WARRANTIES AVAILABLE

Warning Lights

L54 LED LAMP

The L54 unit is specifically designed to mount in tight spaces.

Despite a low profile ensuring discreet mounting, it boasts powerful light output from 6 high power LEDs.

- Available as a single lamp or as a kit with 2 lamps
- A range of optional mounting brackets available to order
- 12 volt and 24 volt operation
- 3 year warranty
- ECE R65 Class 2 and ECE R10 approved

COLOURS AVAILABLE:



Mini Stealth - Surface Mount LED LAMP

The horizontal surface mount Mini Stealth is available as a 3-way single colour module or 6-way/12-way single or dual colour modules. 6-way vertical options are also available.

- 6-way dual colour options are independently switchable
- 12 volt and 24 volt operation
- 5 year warranty
- 3-way modules are ECE R65 Class 1, 6 and 12-way modules are ECE R65 Class 2, all versions ECE R10 approved

COLOURS AVAILABLE:



Mini Stealth - Hood Mount LED LAMP

The horizontal hood mount Mini Stealth is available as a 3-way single colour module or as 6-way single or dual colour modules. 6-way vertical options are also available.

- 6-way dual colour options are independently switchable
- 12 volt and 24 volt operation
- 5 year warranty
- All versions are ECE R65 Class 1 and ECE R10 approved

COLOURS AVAILABLE:



L52 LED LAMP

The L52 is a high performance, slimline unit with integral driver.

Available in single colour horizontal or vertical mounted or dual colour horizontal mount only.

- Available as single colour, dual colour or smoked lens modules
- Window shields and mounting brackets available
- 12 volt and 24 volt operation
- 3 year warranty
- ECE R65 Class 2 and ECE R10 approved

COLOURS AVAILABLE:



Zephyr LED LAMP

The Zephyr LED lamp is available as a 3-way single colour module or as 6-way and 12-way single or dual colour modules.

- Ultra low profile at under 7mm in height
- 12 volt and 24 volt operation
- 12 month warranty
- 12-way version is ECE R65 class 1, all versions are ECE R10 approved

COLOURS AVAILABLE:



Halo Blitz LED LAMP

Halo Blitz warning lamps have a row of 6 high power LEDs at the centre to act as a flashing warning light and an outer halo of 18 long life LEDs to act as a marker lamp.

- Multiple wiring options to achieve a variety of lighting effects
- 12 volt and 24 volt operation
- 5 year warranty
- ECE R65 Class 1 and ECE R10 approved

COLOURS AVAILABLE:



Xtreme Slim LED LAMP

The Xtreme Slim is available as a 12-way single or independently switchable dual colour as well as a 6-way version in single colour only.

At only 10mm in height it is inconspicuous when installed yet highly visible in operation.

- Available as a single colour or dual colour (12-way only)
- 12 volt and 24 volt operation
- 5 year warranty
- ECE R65 Class 2 and ECE R10 approved

COLOURS AVAILABLE:



Reactor LED LAMP

The Reactor is a small, extremely bright LED module complete with a steady mode and CAP 168 approved static flash.

The unit is available single colour and has 4 leds.

- Ingress protected to IPX9K
- 12 volt and 24 volt operation
- 5 year warranty
- ECE R65 Class 1 and ECE R10 approved

COLOURS AVAILABLE:



Edge Dagger LED LAMP

The Edge Dagger is a small slimline LED module with 6 high power LEDs and unique optical reflectors for effective light output.

Available as single colour with clear or smoked lens and independently switchable dual colour.

- Adjustable window shields available
- 12 volt and 24 volt operation
- 5 year warranty
- ECE R65 Class 2 and ECE R10 approved

COLOURS AVAILABLE:



Flex LED LIGHTHEAD

The NEW Flex LED lightheads have a flexible silicone lens and base that can bend up to 120° without compromising on performance.

NEW!

They are supplied with an adhesive mounting pad for shallow applications alternatively the unit can be secured with traditional fixings.

This module is ideal for use on the smooth contouring of electric vehicles.

- Available as a 6 LED single colour unit or a 12 LED dual colour module
- Supplied with adhesive mounting pad and optional fixings
- Optional screw hole cover caps supplied
- Aerodynamic styling reduces wind drag
- Mount on a flat or curved surface
- 12 volt and 24 volt operation
- Ingress protected to IP67
- ECE R65 Class 1 and ECE R10 approved



COLOURS AVAILABLE:



MS Prime MULTI-FUNCTION WARNING LAMP

The MS Prime has an independently controlled top row of 30 steady burn LEDs that can act as a tail/brake light, front position lamp, reversing or scene light.

The bottom row has either 30 (dual colour) or 45 (tri Colour) high power LEDs creating a multi-functional warning lamp.

The unit also has the option of a sequential flash pattern for use as a director bar.

- Available with a dual or tri colour warning light
- Multi-purpose top row of steady burn LEDs
- Supplied with versatile mounting brackets
- Ingress protected to IPX7
- 12 volt operation only
- 290mm long x 30mm wide x 23mm high
- 5 year warranty
- ECE R65 Class 2 and ECE R10 approved



NEW!

COLOURS AVAILABLE:



Micro Blast DISCREET LED LAMP

The Micro Blast is a small, powerful warning light with 3 high power LEDs.

Micro Blasts have the control unit built in to the module saving on space.

- Available as a single lamp
- Supplied with rubber mounting grommet
- Optional additional mounting brackets available to order
- 12 volt and 24 volt operation
- 5 year warranty
- ECE R65 Class 2 and ECE R10 approved



COLOURS AVAILABLE:



Pop-n-Lock DISCREET LED LAMP

The Pop-n-Lock is a single low profile LED module with 6 high power LEDs and an integral rubber grommet that allows the unit to push fit into a pre-drilled hole successfully securing it in position.

Single colour or independently switchable dual colour.

- Self contained module, no external flasher
- 12 and 24 volt operation
- 5 year warranty
- ECE R65 Class 2 and ECE R10 approved



NOW AVAILABLE WITH DISCREET TINTED LENSES!

COLOURS AVAILABLE:



Directional Fend-off COVERT LED LAMP

Directional Fend-off covert LED modules are supplied in pairs in single colour or independently switchable dual colour.

- Mount in a pre-drilled hole within the vehicle light cluster
- Optional bezel for surface mounting available
- Optional lighting shield also available
- 12 volt operation only
- 5 year warranty
- ECE R10 approved



COLOURS AVAILABLE:



Micro Burst DISCREET LED LAMP

Micro Burst LED modules are supplied in pairs in single colour or independently switchable dual colour.

Single colour has 4 LEDs per lamp while dual colour have 6 LEDs per lamp.

- Supplied with rubber mounting grommet
- Optional mounting brackets also available
- 12 volt and 24 volt operation
- 5 year warranty
- ECE R65 Class 1 and ECE R10 approved



COLOURS AVAILABLE:



Octa-Fit COVERT LED LAMP

Octa-Fit Covert LEDs are a pair of discreet LED modules ideal for installation within the door mirror indicator housing, they feature an inhibitor that overrides the hazard lighting when the turning indicator is activated.

The extremely small size of these discreet yet powerful covert lights makes them the ideal solution for mounting in other areas of the vehicle, for instance - the tailgate, front and rear light clusters and within the vehicle windows with the use of a custom designed 3D printed shield.

- Self contained modules, no external flasher
- Optional lighting shield also available
- 12 or 24 volt operation only
- 2 year warranty
- ECE R10 approved



PICTURE FOR SCALE ONLY!

OPTIONAL LIGHTING SHIELD

Warning/Scene Lights

R6 LED LAMP

The R6 is a large scale 12 LED warning lamp available in amber, blue, red and white with clear or coloured lenses. Also available as a scene light (see below).

- Supplied with foam rubber mounting gasket and high gloss mounting bezel as standard
- 16 built-in flash patterns
- 12 volt and 24 volt operation
- 5 year warranty
- ECE R65 Class 2 and ECE R10 approved



COLOURS AVAILABLE:



R4 LED LAMP

The R4 is an effective 8 LED warning lamp available in amber, blue, red and white with clear or coloured lenses.

- Supplied with foam rubber mounting gasket and high gloss mounting bezel as standard
- 16 built-in flash patterns
- 12 volt and 24 volt operation
- 5 year warranty
- ECE R65 Class 2 and ECE R10 approved



COLOURS AVAILABLE:



OV9 CORNER LED LAMPS

OV9 LED modules are sold in pairs and are available in amber and blue with either clear or coloured lenses and have 9 high power LEDs per module.

ECE R65 compliant when installed correctly: 4 units offer full 360° coverage approved to R65 category T class 2 (Blue) while 2 units offer 270° coverage approved to R65 category HT class 2 (Blue).

- Supplied with adjustable mounting brackets
- 12 volt and 24 volt operation
- Ingress protected to IPX7



COLOURS AVAILABLE:



R6 LED SCENE LIGHT

The R6 scene light is a large scale 12 LED lamp available in white only with clear lens. The angled optics of the lens cast the light down towards the ground.

- Supplied with foam rubber mounting gasket
- 1060 effective lumen output
- 12 volt and 24 volt operation
- Ingress protected to IPX7
- 5 year warranty
- ECE R10 approved



M080 SceneMax Combination Lighthouse

The M080 SceneMax lighthouse is a 2-in-1 unit that provides both a powerful warning light and a wide angle scene light.

Automatic cruise mode when the scene light is on.

- 197.5mm wide x 56mm high
- 1420 effective lumen output
- 12 volt and 24 volt operation
- Ingress protected to IPX7
- 5 year warranty

COLOURS AVAILABLE:



NEW!



Stealth Reg Plate NUMBER PLATE WARNING LIGHT

The Flexible Stealth Reg Plate has a rubber body which allows the unit to follow the contours of car bumper as well as sitting perfectly on a flat bumper.

6-way LED modules set at Split Quad Flash are inset at each end of the unit.

- Mount behind the existing registration plate
- 12 volt and 24 volt operation
- 5 year warranty
- ECE R65 Class 2 and ECE R10 approved

NOW AVAILABLE WITH DISCREET TINTED LENSES!



COLOURS AVAILABLE:



SL157 SLIMLINE LED SCENE LAMP

The SL157 Slimline LED Scene Lamp features 4 high power LEDs set at 45° for optimum light output.

Available with a black or white body and die cast aluminium base for excellent heat dissipation.

- Supplied with mounting gasket
- 890 effective lumen output
- 12 volt and 24 volt operation
- Ingress protected to IPX7
- 5 year warranty
- ECE R10 approved



SL209 CURVED LED SCENE LAMP

The SL209 LED Scene Lamp features 6 high power LEDs set at 42° for optimum light output with a curved body for maximum coverage.

Available with a black or white body and die cast aluminium base for excellent heat dissipation.

- Supplied with mounting gasket
- 1460 effective lumen output
- 12 volt and 24 volt operation
- Ingress protected to IPX7
- 5 year warranty
- ECE R10 approved



Traffic Commander

Programmable LED Matrix Display

The Traffic Commander LED Matrix Display has two distinct versions available. The first is a flip down/up device that is simply programmed and rotated to suit its location and is ideal for covert use with the second being a fixed unit.

The LED text panel consists of 288 next generation Amber LEDs with 6 character static capacity and scrolling function for longer messages.

The kit includes free message editing software and a hand held controller with easy to use function buttons and rubber surround.

- Over 2000 characters/100 words can be stored
- Available flip down, flip up and fixed
- Message editing software - programme your own choice of messages as well as font size and background display
- Large display controller with rubber surround
- Unique preview feature for easy message selection
- Open/close protection control
- Dimming feature - side light connection 50% as standard
- Corrosion resistant, powder coated aluminium and stainless steel construction
- 12/24v operation
- 12 month warranty

Standby RSG's ethos is to continually adapt and improve our product range.

Software has been developed that will allow the Traffic Commander to be operated directly from the vehicle touchscreen through an integrated OEM system.

Contact our dedicated sales team for more information



MCS-NX Next Generation Control Units

Advanced control systems for all your emergency, recovery and utility service vehicle equipment

MCS-NX Control Units are user-programmable devices designed specifically for managing hazard warning lighting and power-related functions on Emergency Services vehicles. They are sophisticated control systems that offer various features to enhance the efficiency and safety of these vehicles during emergency operations.

KEY FEATURES

- The primary function of the MCS-NX range of Control Units is to manage the hazard warning lighting on the emergency vehicle. This includes controlling the activation and deactivation of different lighting systems as required for different emergency scenarios.
- The control units are equipped with powerful 100 or 200 Watt digital sirens that produce both UK and European emergency tones. This allows emergency services to effectively communicate their presence to other road users, ensuring safer responses to emergencies.
- MCS-NX Control Units are designed to be user-programmable, meaning that emergency services personnel can customise and configure the system according to their specific needs. This adaptability ensures that the control unit can be tailored to suit different types of emergency vehicles and operational requirements.
- The control units incorporate discrete on/off inputs that can be connected to various external devices. These inputs enable seamless integration with other vehicle systems and allow for precise control over specific functionalities.
- The control units are capable of managing a wide variety of applications beyond hazard warning lights. This may include controlling auxiliary power outputs for specialized equipment, activating specific vehicle configurations for different situations, and managing communication devices.
- Since these control units are intended for use in emergency services vehicles, they are designed and built to comply with relevant safety standards to ensure reliable and safe operations in critical situations.

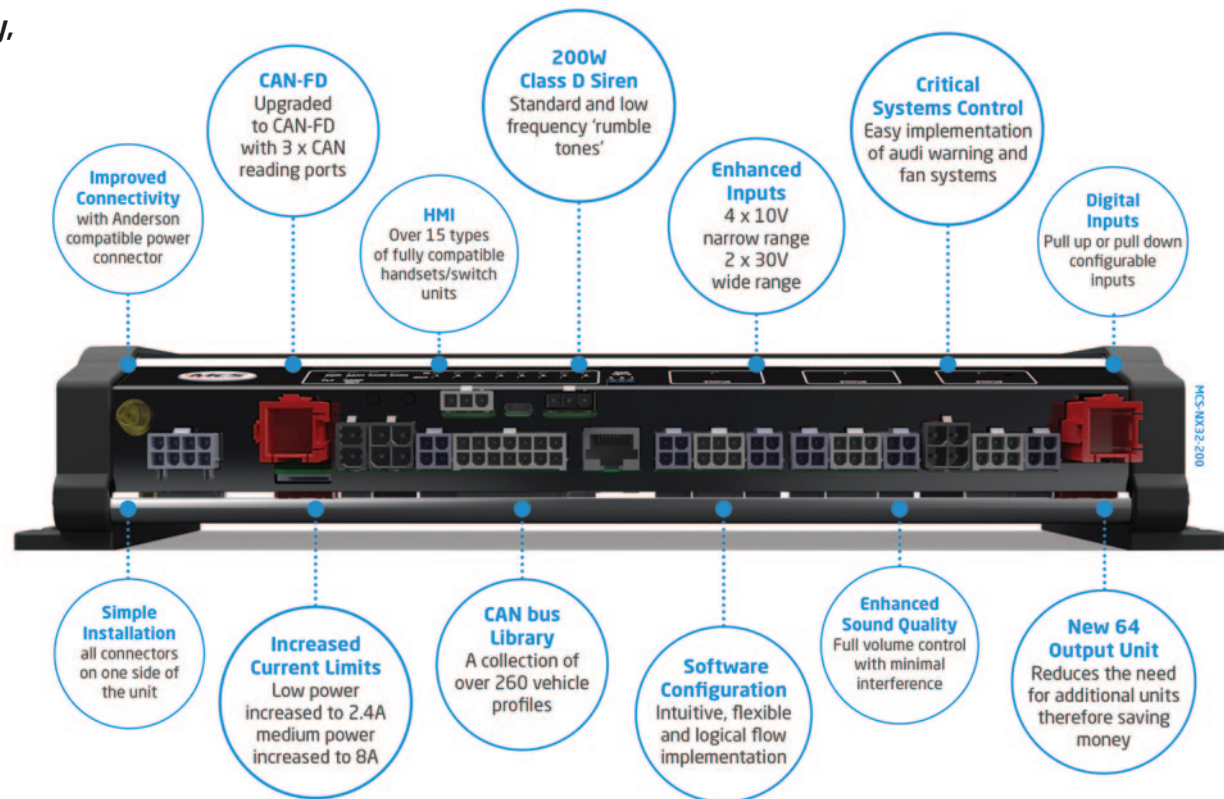

PRODUCT ADVANTAGES

- Reduced loom length, easier to install
- Improved connectivity
- All new configuration software
- Easier diagnostic and fault finding
- Reduced need for additional units
- Medium power outputs current limit increased to 8A
- Low power output current limit increased to 2.5A
- Greater scope during installation for product control allowing for increased load shedding capability
- Flash pattern selectable for group flashing
- Multifunction outputs priority based
- Fully compatible with existing MCS switch units
- 3 x CAN reading ports defined by user (not preset)
- CAN-2.0 (MCS) upgraded to CAN-FD (MCS-NX), allowing for larger data length along with faster BIT rate
- Vehicle CAN integration widened to pick up second CAN line if required
- Class D siren amp for enhanced sound quality with minimal interference (PA)
- Built-in low frequency capability
- Full volume control for workshop/city mode
- Dual voltage - 12v and 24v operation
- Reduced weight

MCS-NX32-S200
32 outputs
200W siren

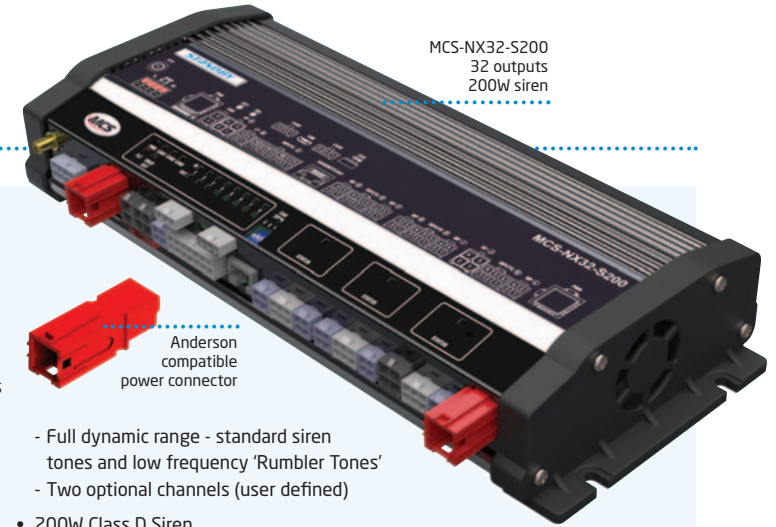

Anderson compatible power connector

ADVANCED FEATURES AND FUNCTIONS

Connections

- Single 70A Anderson power connection
 - NX8 x 1
 - NX16 x 1
- Multiples for larger models
 - NX32 x 2
 - NX64 x 4
- All connections on one side of enclosure

Inputs

- Enhanced inputs
 - Narrow Range x 4
 - Pull up or pull down (configurable), 10V range
 - Wide Range x 2
 - Pull up or pull down (configurable), 30V range
- Inputs used for data input i.e. temperature sensors for dog kennels
- Digital inputs
 - MCS-NX16 x 4
 - MCS-NX32 x 12
 - MCS-NX64 x 28

Outputs

- MCS-NX8
 - High power 20A x 4
 - Low power 2.4A x 4
- MCS-NX16
 - High power 20A x 4
 - Medium power 8A x 8
 - Low power 2.4A x 4
- MCS-NX32
 - High power 20A x 8
 - Medium power 8A x 20
 - Low power 2.4A x 4
- MCS-NX64
 - High power 20A x 20
 - Medium power 8A x 40
 - Low power 2.4A x 4

Multi-Way Switch Options

- CAN handsets/switch units
 - Programmable button configuration
 - 64 colour choices
 - Multiple handset/switch unit setup

- Touch screen switch panel
 - Screen acts as a CAN switch unit
 - 4 x backup buttons
 - On screen buttons interact as per a standard switch unit
 - Fully configurable button/graphic layouts

CAN bus

- CAN-FD x 3
 - CAN-FD x 2
 - CAN-FD/RS485 x 1
- Vehicle CAN bus
 - Supports over 260 vehicle profiles
- MCS CAN
 - Handsets/switch units/touch screen
 - Expansion modules
 - Standby RSG CAN devices

Siren

- 100W Class D Siren (NX8 only)
 - Differential mic input
 - Full digital audio pathing allowing for full volume control

- Full dynamic range - standard siren tones and low frequency 'Rumbler Tones'
- Two optional channels (user defined)
- 200W Class D Siren
 - Differential mic input
 - Full digital audio pathing allowing for full volume control
 - Full dynamic range - standard siren tones and low frequency 'Rumbler Tones'
 - Two optional channels (with selectable outputs)
 - Playback and recording from an SD card
 - Speed based volume

Approvals

- ECE R10 Approved
- Home Office Spec 5 approved
- VCA approved manufacturing facility

SOFTWARE CONFIGURATION

Improving the intuitiveness of the configuration software was key to the development of the NX range. Incorporating new features and functions in a logical order has greatly enhanced the user experience making it easier to navigate and understand.

- A library of pre-built basic functions and specialized modules that users can drag and drop.
- Drag-and-drop functionality to enable users to place modules in the desired order within the logical flow.
- The settings panel provides a clear and concise interface.
- Users can define the execution order of modules to ensure logical flow.
- Allows users to define custom modules by specifying inputs, outputs, and the underlying code or functionality.
- Modules have clear labels and icons for easy identification and differentiation.

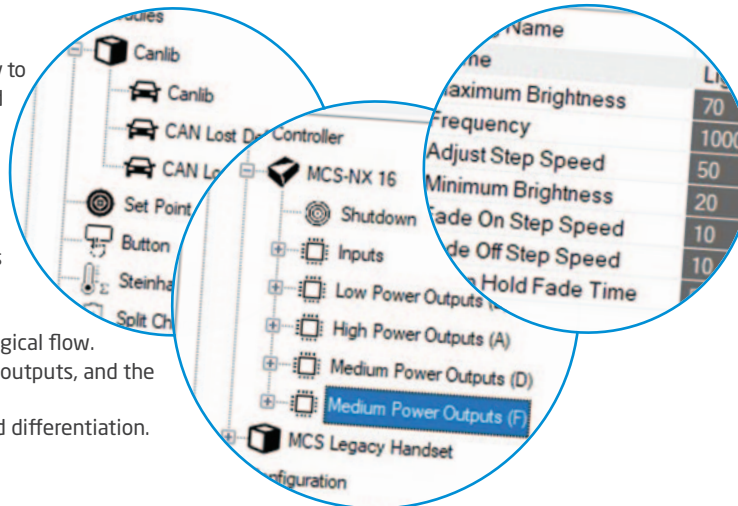

200W SIREN OPTIONS

Unlike the original range of MCS control units, the NX16, NX32 and NX64 are available with 200W siren output.

2 channels, each having 2 selectable outputs allows the unit to produce two different siren tones at the same time giving a 'two vehicle' effect via 2 x 100 Watt speakers, or, scrolled siren sounds via 1 x 200 Watt speaker, plus, either 'simultaneously or separately' a low frequency rumble sound via 1 or 2 x low frequency 100w rumble speakers.



LSP-108
100W Low Frequency
Digital Rumble Speaker

MCS Controller Range

MCS Compact Control Systems

MCS Compact Control Systems consist of one or two MCS-6E multi-functional control units complete with the appropriate switching option. They are quick and easy to set-up and ideal for installations that do not require a great deal of sophistication. They operate by simply translating the press of a button that in turn activates the associated individual or selection of outputs.

The simplest operation is offered by the MCS-6E working in conjunction with one of the discreet switch options; UNO or UNO Advanced, or, the Multi switch systems. The Mini, Midi and Maxi systems have the ability to be programmed directly via a combination of key pad presses, this not only allows initial set-up to be rapidly achieved, but also quick implementation of any changes that may be required.

Uno Systems SINGLE MOMENTARY CYCLIC SWITCH SOLUTION

The entry level Uno systems have two versions available, the first being the Uno and the second being the Uno Advanced.

The UNO has two outputs per button press while the Uno Advanced has three outputs on the 1st press, two outputs on the 2nd press and an additional handbrake input to inhibit the 2nd press if the handbrake is not applied.

Both systems are supplied complete with a pre-programmed MCS-6E Control Unit and momentary cyclic switch.



Uno Latching System MULTI LATCHING SWITCH SOLUTION

The MCS-6E Mini Control Unit is pre-programmed to accept up to 4 positive inputs and 2 negative inputs via suitable latched low current switches, however, not all have to be used as it depends upon the configuration required.

We have a selection of latching switches available to order, for further advice please contact our technical sales department.



Uno Momentary System MULTI MOMENTARY SWITCH SOLUTION

The MCS-6E Mini Control Unit is pre-programmed to accept up to 4 positive inputs and 2 negative inputs to instigate specific individual or multiple outputs (operations such as 999 Emergency Mode and At Scene) via suitable momentary low current switches, other formats may also be implemented.

We have a selection of momentary switches available to order, for further advice please contact our technical sales department.



MCS Mini System 6 CONTROL OUTPUTS

One MCS-6E Control Unit and a 7 button handset provides 6 individual function buttons and 1 combination button. The combination button can have a multi-function 'HOT' key action depending on the required function. Based upon established tactile switch technology that can be 'user' programmed to suit a wide variety of applications.

They are quick and easy to set-up and ideal for installations that do not require a great deal of sophistication. With the ability to be programmed directly from the handset there is no need for a PC and associated software to configure the control unit.



MCS Midi System 12 CONTROL OUTPUTS

Two MCS-6E Control Units are simply ganged together via a CAN Bus connection to double the systems control capacity. Providing two extra outputs with up to 8 individual or combined functions.

A 9 button handset provides 8 individual function buttons and 1 combination button. Based upon established tactile switch technology that can be 'user' programmed to suit a wide variety of applications.

The combination of two MCS-6E Control Units and a 9 Button Handset has all the features and functions of the MCS-MINI, but due to the increased number of switches and associated outputs it is ideally suited to applications needing more of both these operational facilities.



MCS Maxi System 12 CONTROL OUTPUTS

Two MCS-6E Control Units are simply ganged together via a CAN Bus connection to double the systems control capacity. Providing twice the outputs with up to 12 individual or combined functions.

A 14 button handset provides 12 individual function buttons and 2 combination buttons. Based on established tactile switch technology that can be 'user' programmed to suit a wide variety of applications.

Combining two MCS-6E Control Units and the 14 Button Handset has all the features and functions of the Mini System, but due to the increased number of switches and associated outputs it is ideally suited to applications needing more of both these operational facilities.



MCS Control Systems

MCS Control Units are user programmable devices for managing hazard warning lights and power related functions on Emergency Services vehicles. Standard units incorporate a 100 Watt siren with both UK and European tones. These devices incorporate a host of discrete on/off and various data protocol inputs and outputs to control a wide variety of applications.

MCS-32 MULTIFUNCTIONAL CONTROL SYSTEM

The MCS-32 Control Unit consists of a main control box which contains everything required to control a vehicle mounted hazard warning system, typically comprising rooftop lighting, secondary hazard warning lights and audio equipment.

It has 32 outputs and 24 configurable inputs with power management functions including run lock, split charging, load shedding and headlight flash, plus many more, some of which may be implemented via the vehicle CAN Bus system. It also includes a logic switch module to facilitate the control of a Gateway radio with voice alerts.

Operate the controller through one of our range of fully compatible hand held or dash mounted switch units and you have an economical hazard warning control system that does not compromise on features or functionality.

System Intelligence

The main control unit is supplied with default settings that will suit a variety of applications, however it can be simply customised to match the end users specific application by plugging in to a laptop/desktop PC and utilising the 'easy to use' complimentary software.

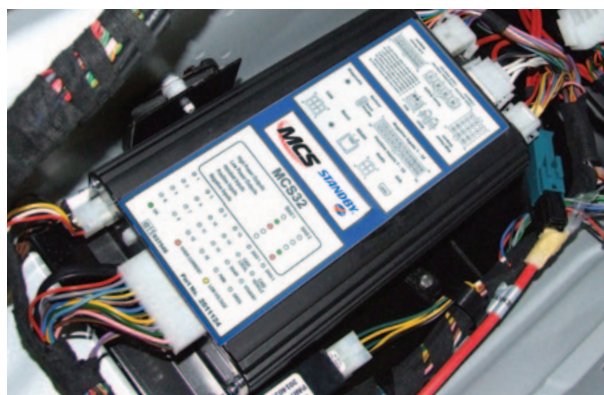

MCS-16 MULTIFUNCTIONAL CONTROL SYSTEM

The MCS-16 Control Unit consists of a main control box which contains everything required to control a 'complete' vehicle mounted hazard warning system, typically comprising of a rooftop lightbar, secondary hazard warning lights and audio equipment.

It has 16 outputs and 16 standard inputs with power management functions including run lock, split charging, load shedding and headlight flash, plus many more, some of which may be implemented via the vehicle CAN Bus system. It also includes a logic switch module to facilitate control of auxiliary add-on devices such as: Gateway Radio Controller, Audio Interface Controller (Intercom with pre-recorded 'voice' alerts) and Fan Controller.

Operate the controller through one of our range of fully compatible hand held or dash mounted switch units and you have an economical hazard warning control system that does not compromise on features and functions.

System Intelligence

The main control unit is supplied with default settings that will suit a variety of applications, however it can be simply customised to match the end users specific application by plugging in to a laptop/desktop PC and utilising the 'easy to use' complimentary software.



The main feature of these devices is their ability to be fully 'user' programmed. Any input or combinations of inputs can be used to control any output or combination of outputs as operationally specified for vehicles used by the Emergency Services. Human machine interface is normally carried out via one of our many multi-Way switch panels or handsets or individual switches.

MCS-8 MULTIFUNCTIONAL CONTROL SYSTEM

The MCS-8 Control Unit consists of a main control box which contains everything required to control a 'complete but optimised' vehicle mounted hazard warning system, typically comprising of a rooftop lightbar, secondary hazard warning lights and audio equipment. It has 4 high power outputs, 4 dual purpose inputs and medium power outputs and 6 dedicated inputs. It also includes power management functions including run lock, split charging, load shedding and headlight flash, plus many more, some of which may be implemented by listening in to the vehicle CAN Bus system. It also includes a logic switch module to facilitate control of auxiliary add-on devices such as: Gateway Radio Controller, Audio Interface Controller (Intercom with pre-recorded 'voice' alerts) and Fan Controller.

Operate the controller through one of our range of fully compatible hand held or dash mounted switch units and you have an economical hazard warning control system that does not compromise on features and functions.

System Intelligence

The MCS-8 is usually supplied as an unprogrammed unit as free PC software for setting up unique configurations, user manuals and training are available on request. Also once a satisfactory configuration has been created it can be transferred to any number of units by use of a laptop.



MCS Sirens, Speakers & Expansion Modules

200 Watt Digital Siren MCS-DDSA

The MCS-DDSA siren incorporates multi mode functionality. Because it is based on digital technology it can operate in different modes on the same installation by utilising different sets of speakers.

Pumping out 200 Watts of 'real' dB power, unlike other offerings that are rated at 200 Watts as that is how much power they consume rather than how loud they actually are.

It can produce two different siren tones at the same time giving a 'two vehicle' effect via 2 x 100 Watt speakers, or scrolled siren sounds via a 1 x 200 Watt speaker, plus, if required either 'simultaneously or separately' a low frequency rumble sound via 1 or 2 low frequency rumble speakers.

See feature on page 14 for more information.



60 Watt Digital Siren MCS-DSA

This 60 Watt Digital Siren can operate either in conjunction with other MCS devices via the on-board CAN Bus interface or as an independent standalone compact device with optional input and output control lines.

MCS-DSA functions and features:

- 12v operation
- Interconnects to related products via proprietary CAN Bus
- Operates via a MCS Multiway Switch Unit or directly via discreet inputs
- Hands free operation via the HRT (Horn Ring Transfer) feature enables scrolling through pre-selected siren tones
- Selectable UK siren sounds with Air/Bull horn option
- Siren active output (ideal as Data Recorder Input)
- City mode volume reduction feature
- On board status LEDs
- Workshop (test) mode volume suppression



100 Watt Siren MCS-SE

Use as a stand-alone device or as part of a blue's and two's system. A compact 100W siren unit which operates at both 12v and 24v and includes a PA facility.

MCS-SE functions and features:

- 12v and 24v operation
- Interconnects to related products via proprietary CAN Bus
- Hands free operation via the HRT (Horn Ring Transfer) enables scrolling through pre-selected siren tones
- Selectable UK and European siren sounds with Air/Bull horn option
- Siren active output (ideal as Data Recorder Input)
- PA & radio re-broadcast facility
- Supports 8 and 11 Ohm speakers
- City mode volume reduction feature
- Workshop mode volume suppression feature for testing



100 Watt Basic Siren MCS-SSA

Use as an economic stand-alone device or as part of a blue's and two's system. A compact 100W siren unit which operates at both 12v and 24v.

MCS-SSA functions and features:

- 12v and 24v operation
- Interconnects to related products via proprietary CAN Bus
- Can be enabled from an input or compatible switch
- Hands free operation via the HRT (Horn Ring Transfer) enables scrolling through pre-selected siren tones
- Selectable UK siren sounds with Air/Bull horn option
- Siren active output (ideal as Data Recorder Input)
- Supports 8 and 11 Ohm speakers
- On board status LEDs
- City mode volume reduction feature
- Workshop mode volume suppression feature for testing



200 Watt Round Speaker - Digital LSP-204

Our most powerful speaker designed to operate in conjunction with a 200 Watt siren and PA amplifier.

- 200W output power rating
- 4 Ohms impedance
- Suitable for 200 Watt siren and/or PA operation
- Strong cast metal housing and formed metal cowl
- Heavy duty metal mounting bracket
- Powder coated to prevent rusting



100 Watt Low Frequency Speaker LSP-108

Designed to take full advantage of the low frequency rumble tone function available from our 200 Watt Digital Siren (MCS-DDSA).

The speaker utilises the 'ground effect' producing penetrating/vibrating low-frequency sound waves that can be physically felt. Highly effective in dense urban environments with heavy vehicle traffic, clearing traffic more effectively than a standard siren tone.

This unit can be used independently or simultaneously with other siren speakers to produce multiple tones.

See feature on page 14 for more information.



100 Watt Round Speaker LSP-210-01

Our 100w Round Speaker features a cast metal housing with formed metal cowl and is powder coated to prevent rusting.

It has a 127dB(A) output at 1 metre and is suitable for 60w or 100w operation.

- 8 Ohms impedance
- Suitable for 60 watt and 100 watt siren operation
- Cast metal housing and formed meta cowl
- Strong construction designed to withstand knocks and bumps
- Heavy duty metal mounting bracket
- Powder coated paint to prevent rusting



Flexi-tube Siren Extension 11-1023

The Flexi-tube Speaker extension consists of a tubular, moulded plastic sound pipe that directs the sound to the front of the vehicle without compromising the quality or pitch of the siren tones.

It directly replaces the speaker cowl of our LSP-210 and LSP-204 speakers as well as other standard round speakers.

Supplied complete with 1 metre of flexible hose that can be trimmed to an alternative length if required and all necessary clamps for easy installation.

Extra hose can be procured separately if required.

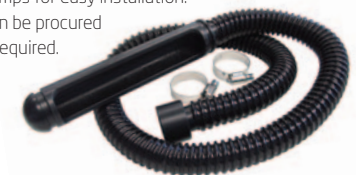

Rumble Effect - 200W Low Frequency Digital Siren MCS-DDSA

Digital amplification technology generates a more noticeable sound both in terms of dB and audible perception. Plus, has the integrated capability to produce a 'Rumble Effect' by generating penetrating/vibrating low frequency sound waves that migrate through solid objects so the siren can be physically FELT!

The low frequency rumble tone feature contributes to improving emergency vehicle operator and public safety, especially in high density urban environments. It also aids with clearing road junction passage.

When used with specific speaker combinations (see below), to optimise the low frequency tones generated from the siren amplifier the output is a highly distinguishable 'Rumble' sound. As the sound is notably different to standard siren tones this feature immediately attracts peoples attention and gives a better sense of the direction the vehicle is coming from.

- 12 and 24 volt operation
- Interconnects to related products via proprietary CAN Bus
- Operates via a MCS Switch Units or directly via discreet inputs
- Hands free operation via the HRT (Horn Ring Transfer) feature enables scrolling through pre-selected siren tones
- Selectable UK siren sounds with Air/Bull horn option
- Siren active output (ideal as Data Recorder Input)
- City mode volume reduction feature
- Workshop (test) mode volume suppression



Typically fire appliances or larger 4x4 vehicles

Connect to siren amplifier output 1 in parallel

OR
Connect to siren amplifier output 2

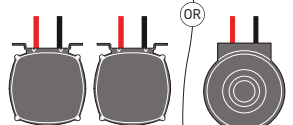

2 x digital rumble speaker:
100 Watts, 8 Ohm
LSP-108

1 x digital speaker:
200 Watts, 4 Ohm
LSP-204



Typically 4x4 or larger patrol vehicles

Connect separately to outputs 1 & 2

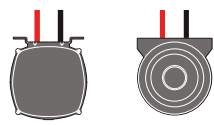

1 x digital rumble speaker:
100 Watts, 8 Ohm
LSP-108

1 x electronic speaker:
100 Watts, 8 Ohm
LSP-210



Typically traffic or fast response cars

Connect to output 1



1 x digital speaker:
200 Watts, 4 Ohm
LSP-210



Typically any suitable vehicle

Connect separately to outputs 1 & 2

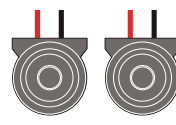

2 x electronic speakers:
100 Watts, 8 Ohm
LSP-210

MCS-LBC Lighting Breakout Controllers

Lighting Breakout Controllers are used to expand the input and output functions of a MCS Control Units.

These devices can be fitted within a lightbar to convert from a multi-wired input to a two wired CAN Bus input, as a light head breakout box to create nodes elsewhere or as a low cost control head to expand MCS systems.

MCS-LBC-10

The LBC-10 takes a CAN Bus encoded signal and converts it into a set of up to 10 conventional on/off (12 volts on and 0 volts off) signals to turn lights and/or other control units on and off.

MCS-LBC-20

The main application of the LBC-20 is to operate as a CAN Bus interface between a MCS Control Unit and any traditionally switched Lightbar via a multi-cored cable (one wire per on/off function).

This device would normally be fitted within the lightbar and as such it only has 4 wired connections (+ve, -ve, CAN High and Low).



MCS CAN Bridge Devices

Modules with unique firmware that provide a link from various MCS devices (typically MCS control units and matrix displays) to either a third party lightbar or a Mobile Data Terminal (MDT). Although common hardware can sometimes be used, each application generally requires a unique firmware solution.

CAN Bridge to Lightbars

Links MCS devices to 3rd Party new and legacy lightbars.

A device that forms a bridge between a MCS CAN Bus connection and a CAN Bus port on another manufacturers lightbar. This is normally achieved by reverse engineering the CAN Bus signal originating from within the lightbar.

CAN Bridge to Mobile Data Terminals

Links MCS devices to 3rd Party new and legacy Mobile Data Terminal (MDT) equipment

A device that forms a bridge between a MCS CAN Bus connection and a CAN Bus port on another manufacturers MDT equipment.

- Many devices for standard applications now available



MCS Switch Options

We have a variety of switch options with a minimum of 5 to a maximum of 16 individual buttons. Handsets have a built-in microphone and push to talk (PTT) if required. Audio output for surface/flush mounted units would be achieved via a hand held microphone with a PTT switch. We now also have a range of switch panels with a cast aluminium surround as well as a touch screen control panel.

T8 Mini Switch Unit UNI-MIN

Our standard T8 Mini Switch Unit consists of 8 small buttons or 7 buttons (six small and one double) with the appropriate legend and key colour, however, combining 2 small buttons to make 1 large button the unit can have as few as 4 buttons if required.

Additionally any button can be programmed for use as PTT (Push To Talk) when activating the built-in microphone.

- Small buttons can have dual function increasing versatility
- Button colours are defined by the LED back light
- Fully compatible with the NX range



Dimensions:
111mm (h)
56mm (w)
19mm (d)

T10 Midi Switch Unit UNI-MID

Our standard T10 Midi Switch Unit consists of 10 small buttons, 9 buttons (8 small and one double) or 8 buttons (6 small and 2 double) with the appropriate legend and key colour, however, combining 2 small buttons to make 1 large button the unit can have as few as 5 buttons if required.

Additionally any button can be programmed for use as PTT (Push To Talk) when activating the built-in microphone.

- Small buttons can have dual function increasing versatility
- Button colours are defined by the LED back light
- Fully compatible with the NX range



Dimensions:
146.5mm (h)
56mm (w)
19mm (d)

T16 MaxiPlus Switch Unit UNI-MHX

Our upgraded T16 Switch Unit has a rigid plastic fascia grid that is secured with 2 small screws vastly improving button definition as well as making it easy for the user to replace/update legends.

The switch unit is also available with an optional sun visor to protect the buttons from glare when mounted horizontally.

The unit is available with 16 buttons, 15 buttons or 14 buttons with the appropriate legend and key colour as standard. Any button can be programmed for use as PTT.

- Fully compatible with the NX range



Dimensions:
153mm (h)
51mm (w)
20mm (d)

T17 Handset UNI-HAP

The T17 is a 16 button handset consisting of 12 individual function buttons, 2 special buttons (Clear All and Walk Test) and 2 combination buttons based upon established tactile switch technology that can be 'user' programmed to suit a wide variety of applications.

This switch unit is designed to be mounted adjacent to the vehicle centre console via a microphone type clip and bracket. A flexible, removable, non-slip, protective rubber surround encases the unit resulting in a robust, hard wearing, professional switch solution.

- Fully compatible with the NX range



Dimensions:
162mm (h)
71mm (w)
19.5mm (d)

F14 Maxi Switch Unit UNI-MAX

The MCS-F14 is available as a 14-Way and 13-Way DIN/Flush mount switch unit as standard.

The Maxi switch unit has 3 versions available which consist of a 14 small button version or a 14 button version with 12 small and 2 large buttons and a 13 button version with 12 small buttons and 1 double button, with appropriate legend and key colour. However, by combining 2 small buttons to make one large button it can have as few as 7 buttons if required.

The unit is designed to be set into the vehicle dashboard or mounted directly onto the dash.

- Fully compatible with the NX range



Dimensions:
176mm (w)
46mm (h)
14.6mm (d)

F16 MaxiPlus Switch Unit UNI-MXF

The MCS-F16 is available as a 16-Way and 15-Way DIN/Flush mount switch unit as standard.

The MaxiPlus switch unit has 2 versions available which consist of a 16 small button version or a 15 button version with 14 small and 1 double button, with appropriate legend and key colour. However, by combining 2 small buttons to make one large button it can have as few as 8 buttons if required.

The unit is designed to be set into the vehicle dashboard or mounted directly onto the dash.

- Fully compatible with the NX range



Dimensions:
176mm (w)
46mm (h)
14.6mm (d)

F5 Slimline Switch Units

The single F5 Slimline Switch Unit was developed to sit alongside an MDT unit. While the dual and triple versions are designed to sit at the top of the dash board.

F5 Single Switch Units:

Consist of 5 buttons (5 small or 4 small and one large) and can be formatted vertically or horizontally as required.

This switch unit was primarily designed for permanent mounting on the dashboard, however it is now supplied complete with a rubber shroud that effectively allows the unit to be used as a handset.



F5D Dual Switch Units:

The F5D Dual Switch unit consist of 10 buttons (8 small or 2 large). This unit is mounted in an appropriate place, ideally above the radio DIN slot or on top of the dashboard.

F5T Triple Switch Units:

The F5D Dual Switch unit consist of 15 buttons (13 small or 2 large). This unit is usually mounted on top of the dash.

Dimensions:

F5	F5D	F5T
124mm (w)	248mm (w)	385mm (w)
32mm (h)	32mm (h)	32mm (h)
14.6mm (d)	14.6mm (d)	14.6mm (d)

All units are fully compatible with the NX range!



T8A Mini Switch Panel UNI-MNT

The T8A Mini Switch Panel is based on the popular T8 Handset. This version was developed to be set into the vehicle dash or panelling.

This unit has a black machined aluminium housing for a long lasting, hard wearing switch solution.

This switch unit has 8 small dual function buttons with appropriate legends and key colours.

Public address would be implemented via a separate hand held microphone with integral PTT switch.

- Fully compatible with the NX range



Dimensions:
15mm (h)
120mm (w)
68mm (d)

P12 Switch Panel UNI-MDP

The P12 Switch Panel was developed to be set into the vehicle dash or panelling of larger emergency services vehicles, such as fire appliances.

This switch unit has 12 large dual function buttons that are approximately 25% larger than those on a standard switch unit, with appropriate legends and key colours.

The switch unit has a black machined aluminium housing for a long lasting, hard wearing switch solution.

Public address would be implemented via a separate hand held microphone with integral PTT switch.

- Fully compatible with the NX range



Dimensions:
17mm (h)
204mm (w)
73mm (d)

T16A Switch Panel UNI-MXT

The T16A Switch Panel is based on the popular T16 Handset. This version was developed to be set into the vehicle dash or panelling.

This unit has a black machined aluminium housing for a long lasting, hard wearing switch solution.

This switch unit has 16 small dual function buttons with appropriate legends and key colours.

Public address would be implemented via a separate hand held microphone with integral PTT switch.

- Fully compatible with the NX range



Dimensions:
15mm (h)
160mm (w)
68mm (d)

T18 Touch Screen Switch Panel

The T18 is a dual purpose switch unit with built-in touch screen panel. It was developed to be set into the vehicle dash or panelling of larger emergency services vehicles, specifically Ambulances.

This switch unit has an integral touch screen which monitors the vehicle battery voltage ensuring optimum battery management as well as 3 primary function buttons. In addition it has 15 traditional function buttons with appropriate legends and key colours.

The switch unit has a machined aluminium housing for a long lasting, hard wearing switch solution.

- Fully compatible with the NX range



Dimensions:
191mm (w)
70mm (d)

MCS-TSC Touch Screen Controller UNI-TSC

The MCS Touch Screen Controller is a Hi-Tech alternative to traditional MCS switch panel solutions giving users direct control over their switch function requirements.

Along with the intuitive touch screen there are 4 built-in direct access buttons for all primary functions.

As this is not currently and out of the box solution, Standby RSG will need to create specific firmware to meet precise end user applications.

When the touch screen is initially powered up the most commonly required screen will appear.

As the operational concept of the Touch Screen Display is based on having a unique screen layout each layer can be assigned a level of importance.

Typical Applications Include:

- Switch Panel Screen - Blue's and Two's
- Battery Monitoring Screen
- Dog Kennel Monitoring Screen
- Prisoner Cell Temperature Screen
- Walk Test Screen
- Locker Check Screen
- Pre-Drive Check Screen

The Touch Screen is normally used in conjunction with the MCS-32, MCS-16 and MCS-8 control units. It can however be formatted for use with other complimentary devices such as the Traffic Commander Programmable Matrix Display and the LSP-204 Digital Siren Amplifier.

- Fully compatible with the NX range



FleetMotus Telematics Devices

The **FleetMotus System** is a Vehicle Utilisation and Driver Behaviour hardware/software tool to monitor and manage fleets or individual vehicles to streamline their deployment reducing accident damage and abuse by encouraging appropriate driving methods. The regular and automated monitoring of vehicle fleets has been proven to save money from the initial installation with around 25% reduction in incidents and approximately 10-20% in fuel costs alone.

The system consists of a vehicle data collection device that connects with back office management software via the mobile phone network and internet/intranet.

Standby RSG has been providing Court of Law recognised, journey and incident vehicle data recording systems for over 20 years, where this has been achieved by working closely with both Fleet Managers and Collision Investigators, primarily in the demanding Emergency Services and Public Sector environments. As such it is now best placed to apply this knowledge and experience to other relevant industries.

FleetMotus Options

Nexu

The FleetMotus range consists of the Nexu and Nexu Lite plug and play devices. Simply plug the device into the OBDII port for real time tracking with GPS/GLONASS and GSM connectivity to collect vehicle co-ordinates and other useful vehicle movement data.

Minimus

The second option is the Minimus a very discreet hardwired data processing device with built-in antennas. Incorporating GSM (Mobile Phone Network) / GNSS (Satellite Navigation) and Blue tooth connectivity. Where Bluetooth peripherals can greatly expand device functionality wirelessly.

Medius

The third option is the Medius hardwired but very compact data processing unit with built-in antennas. Incorporating 'new' generation GSM (Mobile Phone Network) / GNSS (Satellite Navigation) Modules to give the fastest 'cold' and 'hot' start-up times. Also, when linked with a suitable CAN Bus adaptor will monitor associated vehicle functions.

Magna

The fourth option is the Magna or Magna Elite hard wired data processing units. They also have GPS/GLONASS and GSM connectivity to collect vehicle location co-ordinates and parameters to facilitate real time tracking with the Elite having the addition of a LV CAN adaptor and/or an RFID Driver ID card reader to provide additional information regarding the drivers and their behaviour.

Each system can facilitate either a locally hosted server or a cloud based web service.

Whether the system operates on a dedicated locally hosted server or a web based service this is via the license incorporated within the purchase of the vehicle device, unless multiple users are required in which case extra user licenses must be procured separately.

FleetMotus Common Features

• Live Vehicle Tracking

- Updates nominally set at 20 seconds or when a parameter (acceleration, braking or cornering) is exceeded by a pre-set amount
- Update period can be set to less than 20 seconds, but will increase data usage and associated fee
- Update period can be reduced from 20 seconds, but not normally necessary as a pre-set parameter could be exceeded first
- Update period can be increased beyond 20 seconds if more appropriate to a specific application and can be set to automatically increase when vehicle is stationary or device is put to 'sleep'

• History Journey Viewing

- View part, single or multiple journeys
- Home in on key events, exceptions and infringements

• Live or Historic Virtual Dashboard

- Shows vehicle status/usage
- Various formats available for best application

• Geo Fencing

- Areas of interest linked to alerts and reports

• Points of Interest Import

- User or postcode defined

• Vehicle Type and Location Tagging

- Facilitates simplified views and like for like reports

• Urgent Alerts and Events

- Notification via SMS text message

• Typical Email Alerts with Scheduled Reports

- Vehicle Utilisation Report
- Idle Vehicle Report (ignition 'ON' with vehicle not moving)
- Special Lazy Vehicle Report (ignition 'OFF' in Geo Fenced locations)
- Over Speed Reports
- Harsh Braking and Acceleration Reports
- Vehicle Battery Monitoring
- Stolen or Towed Vehicle Alert

• Internal Battery Back-up

- Units operate for 30 minutes plus when vehicle supply disconnected.



Nexu Lite DLH-315

Easy plug and play tracking device

The FleetMotus Nexu Lite plugs into the OBDII port for an easy plug and play real time tracking terminal.

Built-in GPS/GPRS connectivity collects device co-ordinates and other vehicle movement data and transfers it to the system host platform or client server.

Typical applications: This device is perfectly suited for applications where the acquirement of location and remote mobile assets is required for: fleet management, vehicle rental companies, taxi firms, personal cars on public highways as well as plant and agricultural off-road vehicles.



Nexu II DLH-310

Advanced plug and play tracking device

The FleetMotus Nexu II plugs into the OBDII port for an advanced plug and play real time tracking terminal.

Built-in GPS/GPRS connectivity collects device co-ordinates and other vehicle movement data including that from the vehicle on-board computer and transfers it to the system host platform or client server.

Typical applications: This device is perfectly suited for applications where the acquirement of location and remote mobile assets is required for: fleet management, vehicle rental companies, taxi firms, personal cars on public highways as well as plant and agricultural off-road vehicles.



Magna II DLH-421

Standard vehicle movement and data recorder

The FleetMotus Magna II is a hard wired data processing terminal for real time vehicle movement and data recording.

Built-in GPS/GPRS connectivity is able to collect device location co-ordinates and parameters to facilitate real time tracking, monitoring of movement and operational data, and transfer it to the system host platform or client server.

In the event of loss of signal coverage the FleetMotus Magna can store more than 16,000 records, once the connection is re-established stored data is sent to the server so that it is not lost.



Minimus DLH-423

Discreet Vehicle Movement and Data Recorder

The FleetMotus Minimus is a discreet hardwired device data processing unit with built-in antennas.

It is a light real-time tracking terminal with GPS/GPRS modules as well as Bluetooth connectivity, which collects device coordinates and other data and transfers to a server. Bluetooth peripherals expand the devices wireless functionality.

Typical Applications:

Where there is a location requirement for remote objects such as for security, fleet management, car rental companies, taxi firms, public transport, logistics companies, personal vehicles and many more.



Medius DLH-422

Compact Vehicle Movement and Data Recorder

The FleetMotus Medius is a hardwired and compact data processing unit with built-in antennas.

Incorporating latest generation GPS/GPRS modules to give the fastest 'cold' and 'hot' start-up times. When linked with a suitable CAN Bus adaptor will monitor associated vehicle functions. The Medius collects device co-ordinates and vehicle movement data to transfer them to the systems Host Platform or Client Server.

Typical Applications: These would be like those for Nexu Lite and Nexu II devices, but with the ability to monitor and record extra vehicle signals or those from auxiliary equipment.



Magna Elite DLH-316

Advanced vehicle movement and data recorder

The FleetMotus Magna Elite has all the features and functions of the standard Magna unit but with the addition of either an RFID Driver ID Card Reader module or i-button and/or Light Vehicle CAN Bus adaptor.

It can provide additional data such as 'who' is driving the vehicle, 'how' it is being driven and 'what' the vehicle is doing as well as monitoring auxiliary equipment.



autoeyeXpert Vehicle Video Systems

Improve road safety, reduce litigation costs, reduce vehicle down-time and enhance driver awareness

The Standby RSG AutoEye Xpert range offers a variety of mobile CCTV solutions that are used in various applications, including emergency services, rescue vehicles, and commercial vehicles. These solutions are designed with a modular approach, allowing for customization based on individual requirements while minimizing waste costs.

One of the key features of the AutoEye Xpert range is its scalability. The systems are available in configurations ranging from 1 to 16 channels, allowing users to choose the appropriate number of cameras based on their specific needs. This flexibility ensures that the system can be tailored to different vehicle types and operational requirements.

The range also includes options for 4G live video streaming, which enables real-time monitoring and remote access to the CCTV footage. This feature is particularly valuable for emergency service providers who require immediate access to video feeds for situational awareness and decision-making.

Secure storage is another important aspect of the AutoEye Xpert range. The systems offer reliable and encrypted storage solutions to ensure the integrity and

confidentiality of the recorded video data. This is crucial for maintaining evidential quality and protecting sensitive information.

Additionally, the range supports WiFi data transfer, allowing for efficient and wireless transfer of video footage to central command centres or other authorized locations. This capability facilitates seamless data sharing and analysis, enhancing the overall effectiveness of the system.

Lastly, the range is known for its ability to capture high-definition images. This ensures clear and detailed video footage, which is essential for identification, investigation, and post-event analysis purposes.

Overall, the Standby RSG AutoEye Xpert range provides reliable, high-quality mobile CCTV solutions that cater to the needs of fire, police, ambulance, and commercial users.

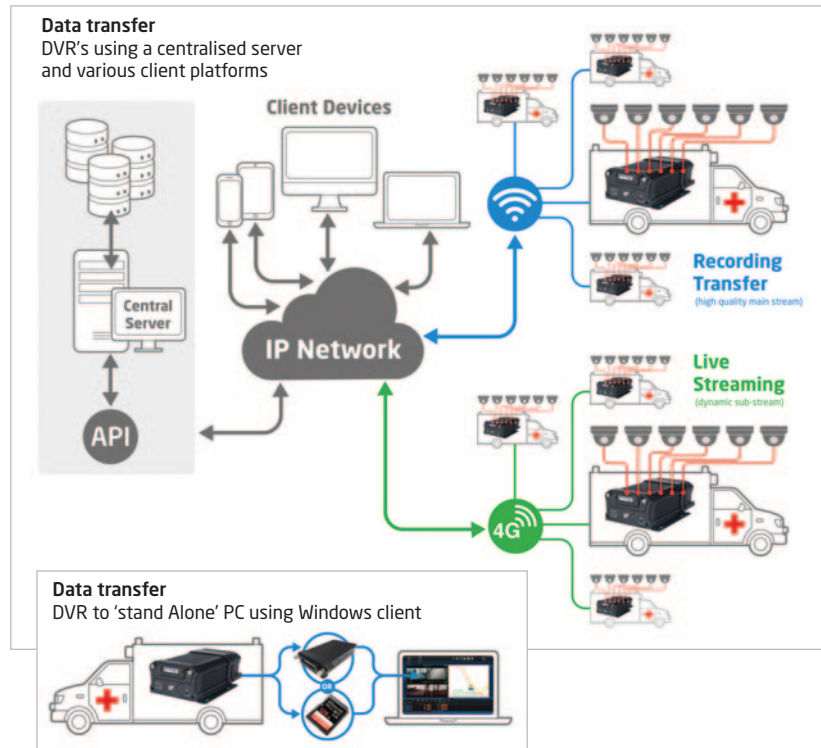

MULTICHANNEL RECORDERS

AEX-ST-DVR-M14W

5 Channel (1 x IP + 4 x AHD) Twin SD Card Recorder

The AutoEye Xpert 5 Channel (1 x IP + 4 x AHD) Twin SD Card Hard Drive Recorder provides powerful monitoring functions.

- Connects 4 x AHD cameras and 1 x IP (PON) camera
- Up to 1080p resolution of H.264/H.265 encoding for each camera channel
- Wireless functions include 4G and Wi-Fi modules providing flexible data transmission solutions for live streaming and downloads
- 2 x SD card slots with up to 256GB of storage per slot
- One CVBS video output interface
- Built-in GPS module for measuring vehicle speed, location and route travelled



AEX-ST-DVR-X31

8 Channel (4 x AHD + 4 x IP) Hard Drive Recorder

The AutoEye Xpert Pro Series 8 Channel (4 x AHD + 4 x IP) Hard Drive Recorder provides powerful monitoring functions.

- Connects 4 x AHD cameras and 1 x IP (PON) camera
- Up to 1080p resolution of H.264/H.265 encoding for each camera channel
- One VGA video output interface with up to 1080p resolution
- 1 x 2.5" HDD/SSD up to 2TB, with built-in shock and vibration protection
- On-board SD card data backup/mirror for enhanced data security
- One CVBS video output interface
- Wireless options include 3G/4G module and Wi-Fi module



AEX-ST-DVR-X54W2

12 Channel (8 x AHD + 4 x IP) Hard Drive Recorder

The AutoEye Xpert Pro Series 12 Channel (8 x AHD + 4 x IP) Hard Drive Recorder provides powerful monitoring functions.

- Connects 8 x AHD cameras interfaces and 4 x IP (PON) cameras
- Up to 1080p resolution of H.264/H.265 encoding for each camera channel
- One VGA video output interface with up to 1080p resolution
- 1 x 2.5" HDD/SSD up to 2TB, with built-in shock and vibration protection
- On-board SD card data backup/mirror for enhanced data security
- One CVBS video output interface
- Wireless options include 3G/4G module and Wi-Fi module



CAMERAS

AEX-ST-VMC-CA2FA

AHD Forward Facing Camera with Audio

The Standby RSG AEX-ST-VMC-C2FA/CA2FA camera is designed for mounting on front or rear windscreens.

It features a robust steel housing, and has a wide angled lens which can capture 3 lanes of highway plus on-coming traffic. The 1080P high definition output signal uses AHD for full compatibility with our DVR's. The high sensitivity camera sensor operates down to 0.05 lux without any additional lighting required, and with headlights this produces great colour images even at night. A standard 4-pin aviation connector ensures compatibility with our extensive range of camera extender cables.



AEX-ST-VMC-C39S

External 1080P Side View Camera

This camera is designed for external mounting on the side of vehicles, typically around the wings, fenders, over wheel arches etc.

It is a PON network camera which connects to the AutoEye Xpert Pro Series of digital video recording units. The camera provides 1080P resolution at up to 30 frames per second, and includes infra red LED's for illumination in dark or low-light conditions. It is extremely robust with an IP69K rating making it ideal for vehicles such as HGV's and vans, but is small enough to also find use on pickup trucks and smaller vehicles.



AEX-ST-VMC-NAR

AHD Number Plate Camera with IR

The Standby RSG AEX-ST-VMC-NAR is a rear view camera designed for mounting adjacent to a vehicle registration plate or tailgate door handle.

It features a 1080P AHD output on 4-pin aviation connector for use with our AutoEye Xpert Pro Series of DVR's. The camera is extremely robust with IP69K housing. The viewing angle offers an extremely wide field of view at 178 degrees wide, and the housing offers easy adjustment up and down to obtain the perfect viewing experience. Built in infra red LED's illuminate up to 5 metres distance in low light conditions.



AEX-ST-VMC-C251

PON Internal Camera with IR & Audio

The AEX-ST-VMC-C251 mini dome IP camera is ideally suited for capturing detailed images in confined areas such as Police cell vans, buses, personnel carriers etc.

It is extremely robust with IP69K housing, and produces a 1080P output via a 6-pin PON interface for our Pro Series of digital video recorders. The camera includes an audio microphone tuned for speech and designed to reject low frequency vibration and engine noise. It has infra-red LED's for viewing in low light conditions and a wide angle lens ideal for capturing detail in small cells.



MONITORS

AEX-ST-TSD-CP4

Dash Mounted 7" Colour LCD Touch Screen Monitor

AutoEye Xpert Pro Series dash mounted, 7" Colour LCD Touch Screen monitor with backlit buttons.

A 7 inch touch screen display that allows single or multi-camera views and playback of recorded footage with tap/point/drag gestures and backlit buttons allow for easy tactile use in dark conditions. Built-in speakers allow playback of audio events and supports VOIP messaging from optional cloud hosted service while the built-in RFID module supports easy access and identification of drivers and operators.



AEX-S-MON-1

19" HD Monitor for Mobile CCTV Systems

The AEX-S-COM-1 ruggedised monitor is a 19" screen size offering full high definition 1080P resolution. It is perfect for use with our AutoEye Xpert Pro Series of mobile DVR's as it supports connection to VGA and composite signals, as well as supporting 12V DC power and mains power options.

The monitor can be desk or wall mounted and includes a versatile bracket which can be removed if preferred. Its sturdy metal chassis protects the screen in harsh mobile environments.



SOFTWARE

Cloud based software, services and client applications

The Standby AutoEye Xpert Pro Series of digital video and telematics systems is supported by a range of user interfaces and data collection platforms. For small deployments we provide a stand-alone PC desktop application which interfaces directly with the DVR storage media (USB, SD card, or desktop reader).



KEY FEATURES

- A range of software applications and services for AutoEye Xpert mobile video telematics platforms
- Client applications for Windows, iOS, Android and browser-based web app
- Data hosting within user-specified geographic regions
- Cloud and local backup solutions
- Centralised evidence management
- Live streaming over cellular networks
- Mapped fleet locator with real-time updates and route marking
- Alarm and event-based triggers for push notifications, automated uploads, and data filtering
- Custom alarm and event markers for blues, siren, arrive at scene, and vehicle functions such as brakes, indicators, over speed etc
- Export to popular file formats such as MP4 video and CSV metadata
- Remote text and voice messaging functions
- Defined user access controls for fleet, equipment and data

THIS DOCUMENT SHOWS A BRIEF OVERVIEW OF OUR VEHICLE VIDEO SYSTEMS SEE WEBSITE FOR FULL PRODUCT RANGE

Vehicle Video Systems

Pan-Tilt-Zoom - Police Safety Camera Van System

The UK's Police Service is made up of 48 civilian police forces: 43 territorial police forces in England and Wales and a national force in both Scotland and Northern Ireland. These forces cover over 94,000 square miles and 7,700 miles of coastline with an estimated population in excess of 67 million people, a road network of more than 247,000 miles, and arterial routes traversing the country.

A number of forces have invested in new resources to combat the rising problem of speeding motorists on the county's roads, but also to help protect their speed enforcement teams whilst performing their duties at the roadside.

One of the frustrations encountered by speed enforcement officers is that, by law, motorcycles do not have to have a front registration plate, therefore the in-vehicle rear facing static speed camera can't capture the plate details of a speeding motorcyclist. The Standby RSG, Autoeye Xpert Pro, PTZ system combats this problem with a rooftop Pan-Tilt-Zoom camera operated by a joystick controller and viewed on an optional HD monitor from inside the vehicle. This system is ideal for installation on new builds, however, it is possible to retro fit on to existing vehicles.



Dash Cameras

AEX-ST-DMC-MINI

Mini Dashcam

As a professional, user-friendly, and cost-effective dash camera, the AutoEye Xpert Mini Dashcam supports 1 channel 2K UHD video recording, dual Micro SD card storage, and dual-stream video recording. In addition, it supports uploading video in real-time to a monitoring platform that can be reviewed by fleet managers to guide drivers and reduce traffic risks.

- 2MP resolution with 143° DFOV for road-facing camera
- Built-in Wi-Fi and 4G module
- Support 4-channel input, 1 channel CAN, and 1 channel RS232
- Support OBD powering, easy installation
- Support echo suppression algorithm to improve the quality of two-way voice intercom
- 6-axis gravity sensor detects intense driving behaviours (Harsh Acceleration, Deceleration, Sharp turn & Accident detection)



AEX-ST-DMC-MIDI

Midi Dashcam

As a professional, user-friendly and cost effective dash camera with built-in AI processor, the AutoEye Xpert Midi Dashcam detects risky driving events such as lane departure warning, forward collision warning and headway monitoring warning, as well as unsafe driving behaviours such as unfastened seatbelt, using mobile phones, yawning, distraction and smoking.

- 1080P resolution with 96°DFOV for ADAS, 1080P resolution with 170°DFOV for DSC
- Support up to 3-channel video recording, H.264/H.265 video coding
- Support 4-channel input, 1 channel CAN and 1 channel RS232
- Built-in ADAS and DSC, supporting AI event detection (up to 2-channel)
- Support sleep mode, remote wake-up (power consumption less than 0.1W)



AEX-ST-DMC-MAXI

Maxi Dashcam

The Autoeye Xpert Maxi Dashcam is an AI dashcam that helps drivers to reduce traffic accidents and facilitates fleets to improve management efficiency. Based on AI technology, it can actively detect risky driving events and unsafe driving behaviours, supporting sending local real-time reminders to the driver to avoid risks and uploading events to the fleet management platform for driver training.

- Ultra-wide 140° DFOV road facing lens, supporting up to 1920P UHD recording
- Ultra-wide 170° DFOV driver facing lens, supporting up to 1080P HD recording
- Support up to 4-channel recording H.264/H.265 encoding
- AES256 encryption for video/audio data, encryption protocol TLS1.3 for data transmission
- 4-channel IO input, 1-channel CAN and 1-channel RS232



CARAT Responder Switch System

An effective multi-functional system for emergency service personnel

OVERVIEW

CARAT Responder combines operative functions such as case management, receiving alarms, navigation, radio control, emergency service functions and vehicle functions in the same system.

It is designed for operations with socially critical tasks, and we have built our own operative system to give the user full control for best safety and functionality.

The system is user friendly and the combination with Smart Menu buttons makes it easy to use and navigate through traffic.

All functions are controlled from one screen which eliminates other panels and buttons. This provides a cost-efficient solution and above all, a clean and safer driver environment.

BENEFITS

Standby Smart Menu

A quick and easily accessible menu that gathers the most used functions. You can choose the desired functions for this menu based on your preferences and needs. This menu provides quick access to essential functions.

Case Management

A case can be received from the communication centre via Tetra, a status update is then relayed back to the communication centre.

Emergency Service Functions

Control emergency service functions such as siren, blue lights, work lights and warning lights as well as interior lights, climate control, locks and much more.

Gate Control

Open gates, control traffic lights, bollards and more via Tetra.

Radio Control

Eliminate the traditional radio control panel and control functions such as talk-groups, send status and SDS in a more user-friendly way via the touchscreen.

Navigation

Displays an overview of the case position and provides navigation details with voice guidance.

Updates

The system update package updates all installed Standby units that are connected to the system, keeping the system up to date with new functions.

Safer Driver Environment

The system combines multiple functions into one screen which eliminates other traditional panels for controlling blue lights. This creates a user-friendly system, reduces the number of LED indicators in the driver compartment as well as providing the user with a safe driver environment.

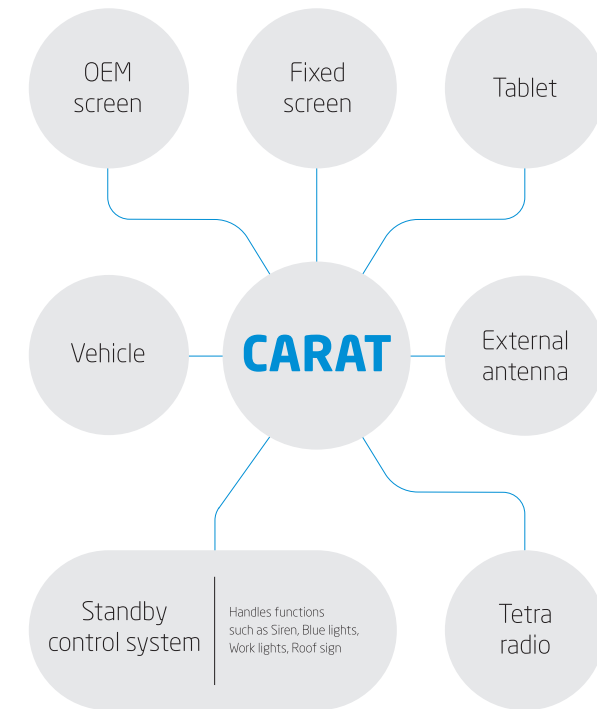
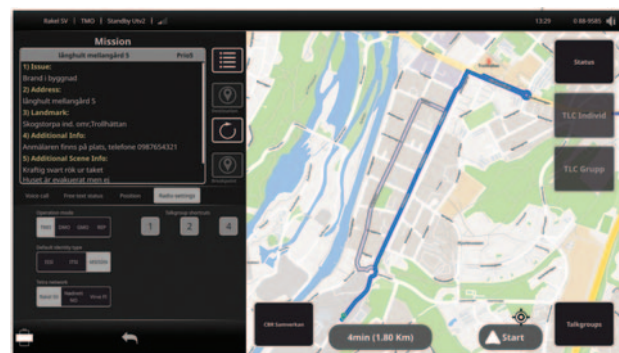

Standby Group

Standby Group employs around 200 people across Sweden, Germany, France, Finland and the UK. Meaning that we can offer our customers First Class service and support wherever they are based in Europe.

Standby RSG's Environmental and Quality Policies

BS EN ISO 14001:2015 certification means that we recognise the importance of Environmental protection and are committed to operating responsibly and in fulfilment of compliance obligations. It is our objective to carry out all necessary activities, to protect the environment.

At Standby RSG we aim to provide defect free products and services to our customers on time and within budget. We operate a quality management system that has gained BS EN ISO 9001:2015 certification, including aspects specific to specialists products for the professional automotive user.



Certificate No: 414862023



Certificate No: 109342020

Standby OyAb
Finland

Standby AB
Sweden

Standby RSG
UK

Standby GmbH
Germany

Standby Mercura
France

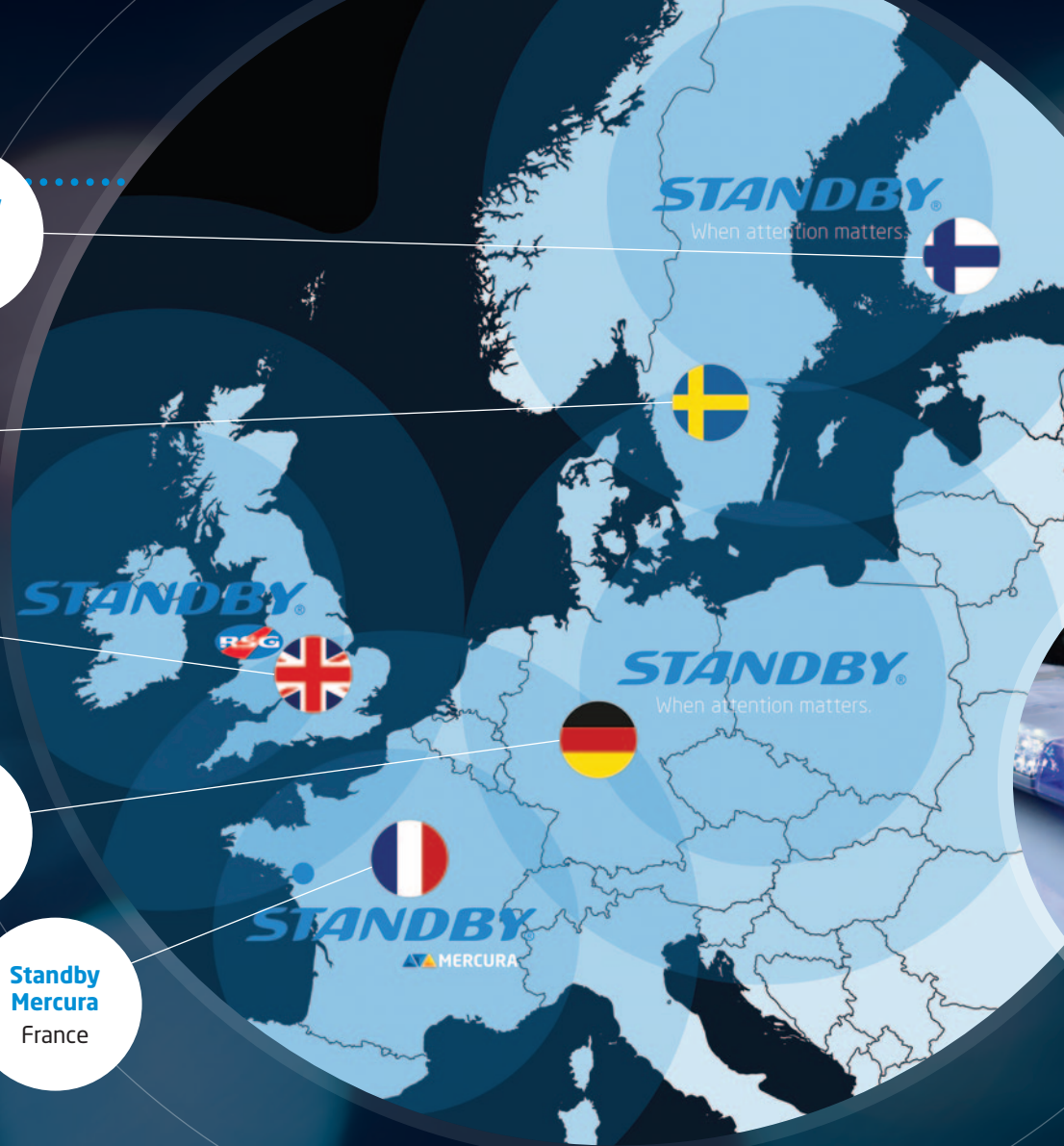

Standby RSG UK Limited

19 Hollies Business Park, Hollies Park Road, Cannock, Staffordshire WS11 1DB, UK.

Telephone: +44 (0)1543 438800 Email: info@standbyrsg.co.uk Web: www.standbyrsg.co.uk